

# Groundwater Hydrology and Water Wells

# Objectives

- ∅ Introduce and review concepts of the hydrologic cycle and groundwater hydrology
- ∅ Introduce and review general water well concepts

# Where is the world's water?

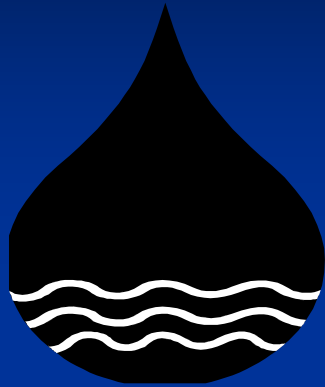

Saline water in oceans: 97.2%



Ice caps and glaciers: 2.14%



Groundwater: 0.61%



Surface water: 0.009%



Soil moisture: 0.005%



Atmosphere: 0.001%



CLOUDS FORM

PRECIPITATION

TRANSPIRATION

RUNOFF

EVAPORATION

INFILTRATION TO GROUND WATER

PLANT UPTAKE

GROUND WATER ACCESSED THROUGH WELL

Hydrologic Cycle

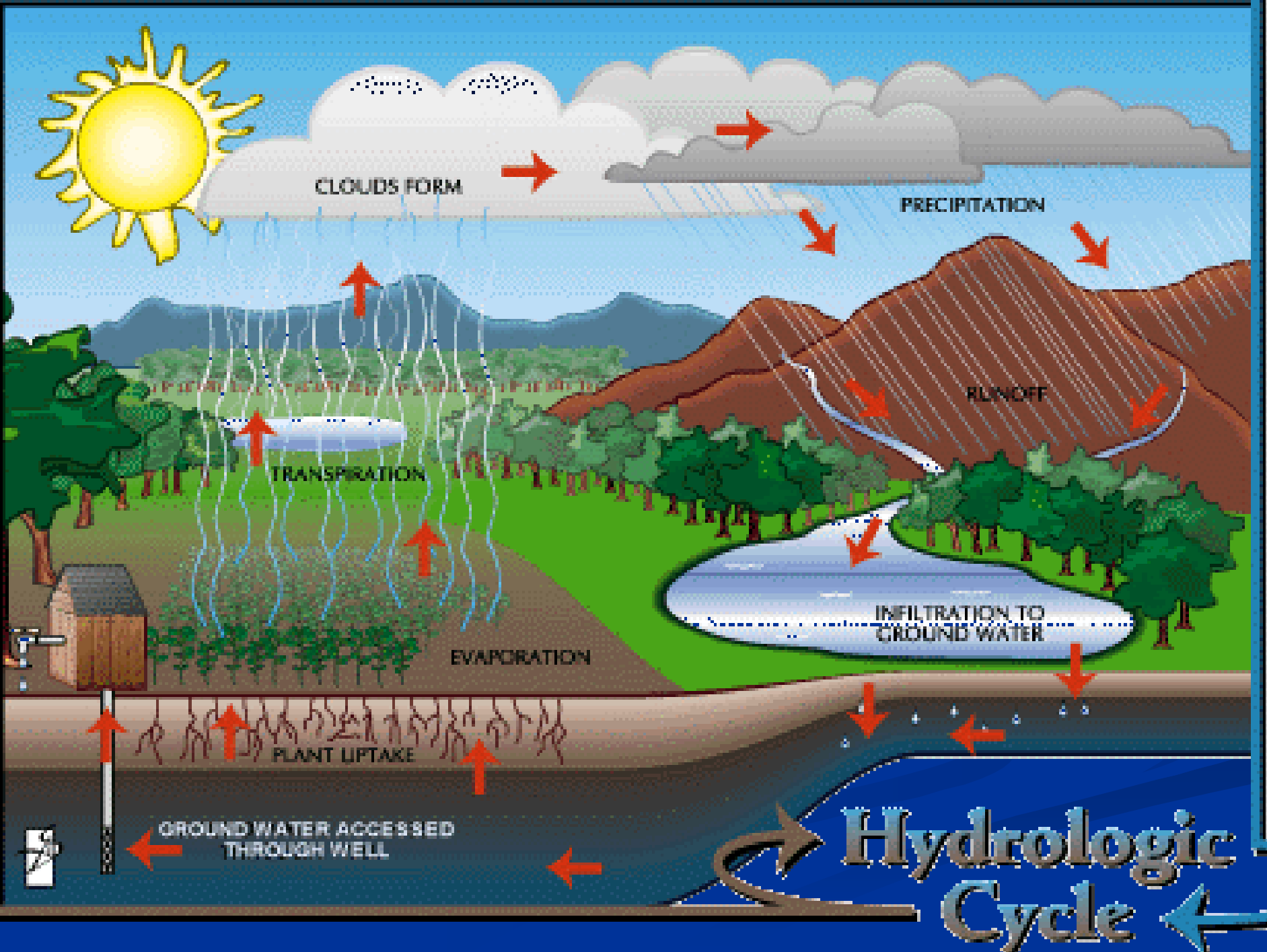

# Introduction to Hydrogeology

# What is an aquifer?

“A geologic formation with sufficient interconnected porosity and permeability to store and transmit significant quantities of water under natural hydraulic gradients”

# 4 Common Aquifer Materials

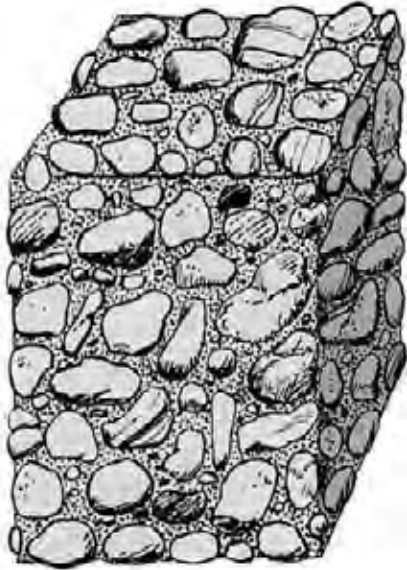

SAND AND GRAVEL

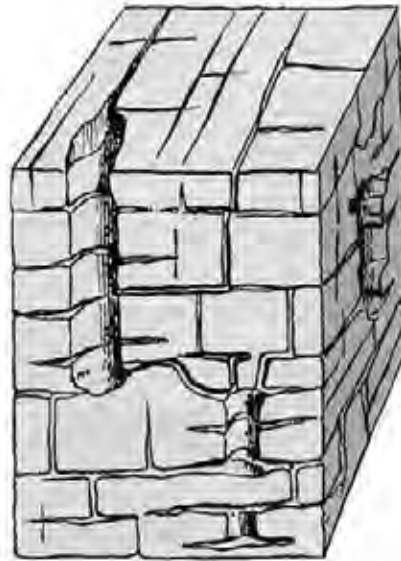

LIMESTONE

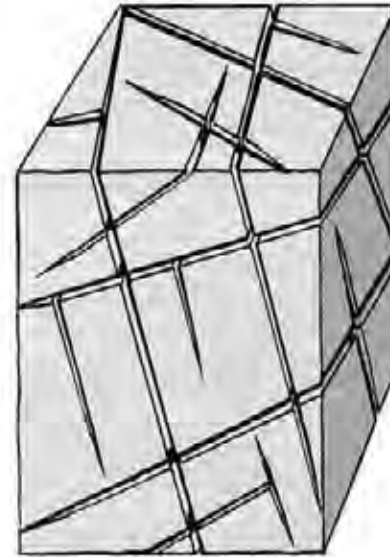

FRACTURED ROCK

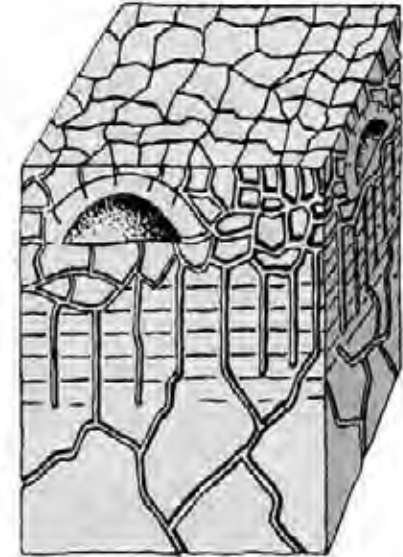

VOLCANIC ROCK

# Aquifer Types

- n Unconfined (water table)
- n Confined
- n Perched



# Unconfined Aquifer

Source: Fetter, 1994

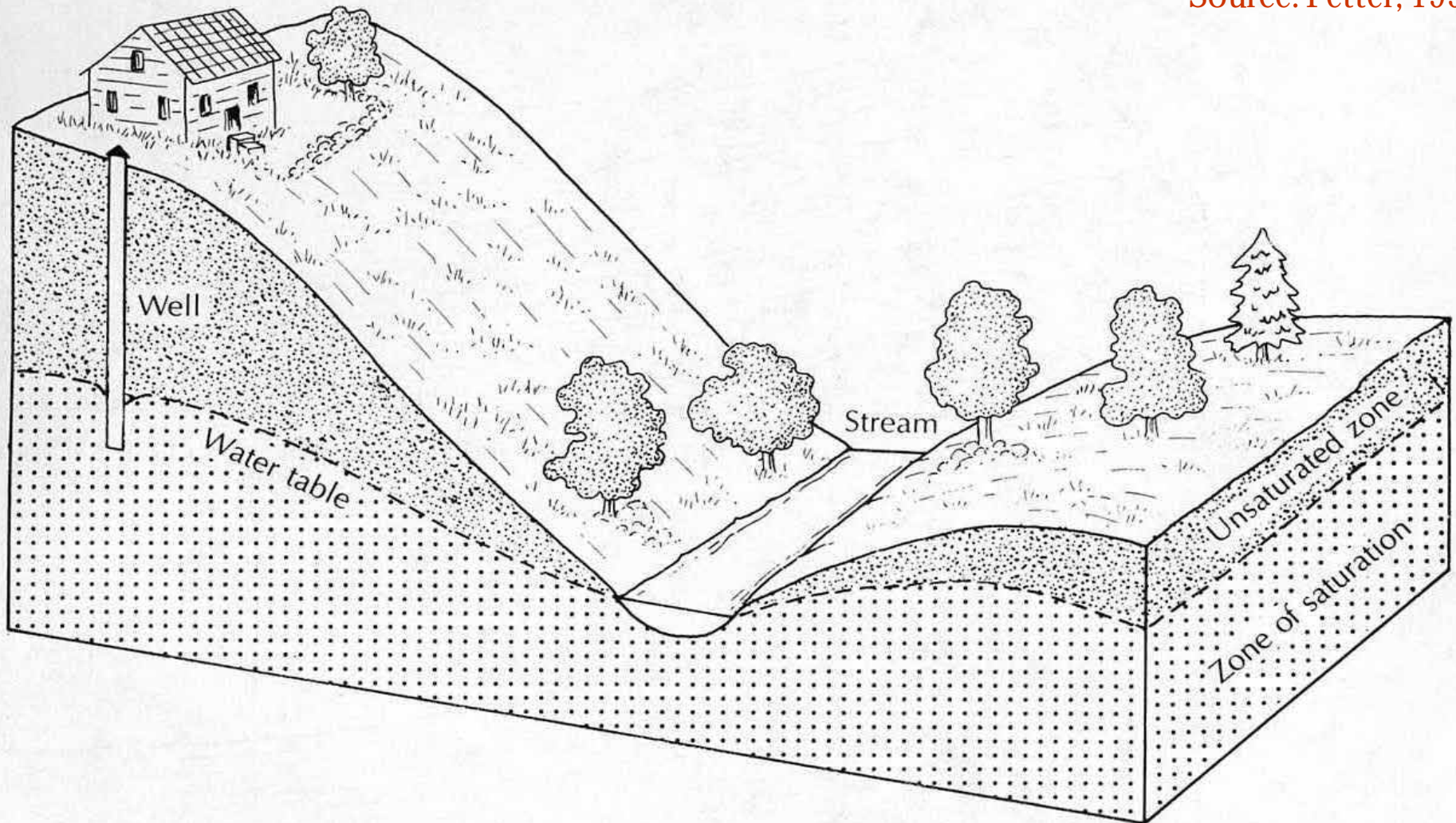

# Confined Aquifer

Source: Fetter, 1994

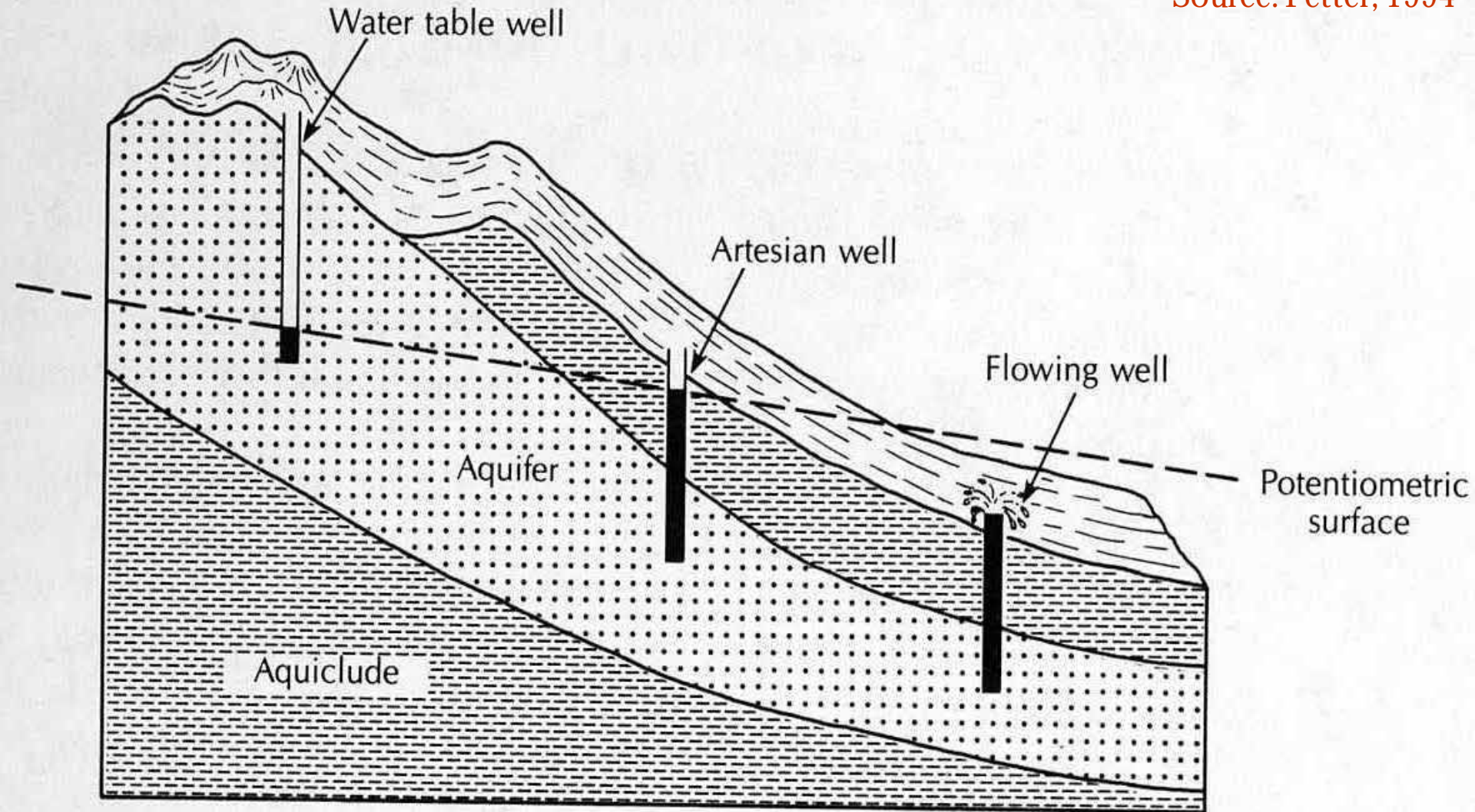



# Perched Aquifer

Source: Fetter, 1994

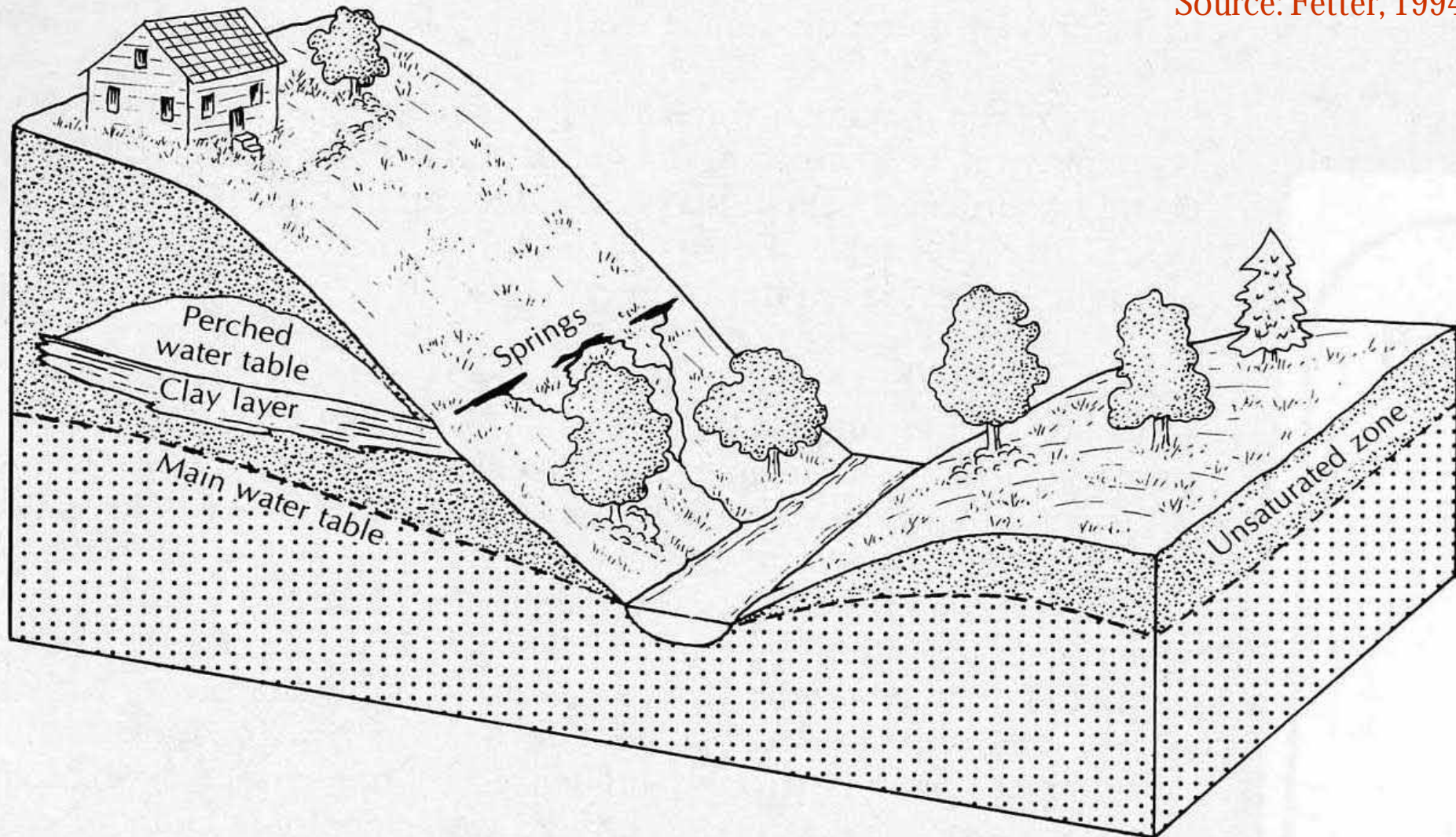

# Groundwater Movement (Henry Darcy)

- 6 Key Concepts
  - Porosity (void volume)
  - Permeability (connectivity)
  - Hydraulic Conductivity (ability to conduct water)
  - Specific Yield (ratio of water per unit of rock or soil)
  - Transmissivity (volumetric flow rate (gal/ft/day))
  - Potential (pressure, elevation, kinetic energy)

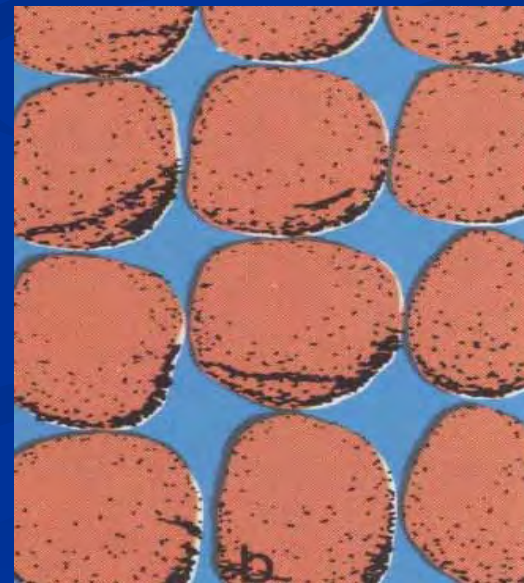
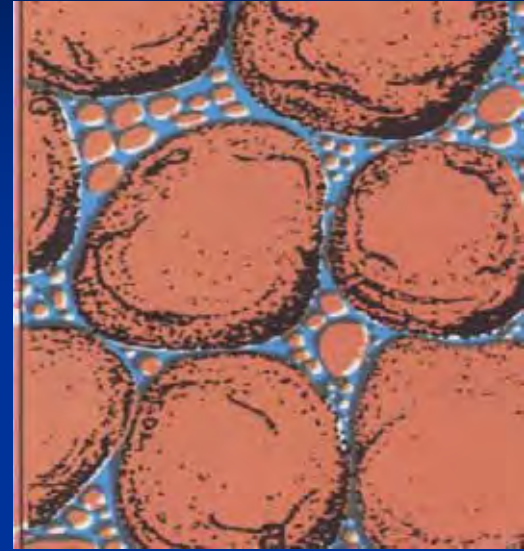

# Porosity Values

Unconsolidated Sediments	$\eta$ (%)	Consolidated Rocks	$\eta$ (%)
Clay	45-55	Sandstone	5-30
Silt	35-50	Limestone/dolomite (original & secondary porosity)	1-20
Sand	25-40	Shale	0-10
Gravel	25-40	Fractured crystalline rock	0-10
Sand & gravel mixes	10-35	Vesicular basalt	10-50
Glacial till	10-25	Dense, solid rock	< 1



# Hydraulic Conductivity Values

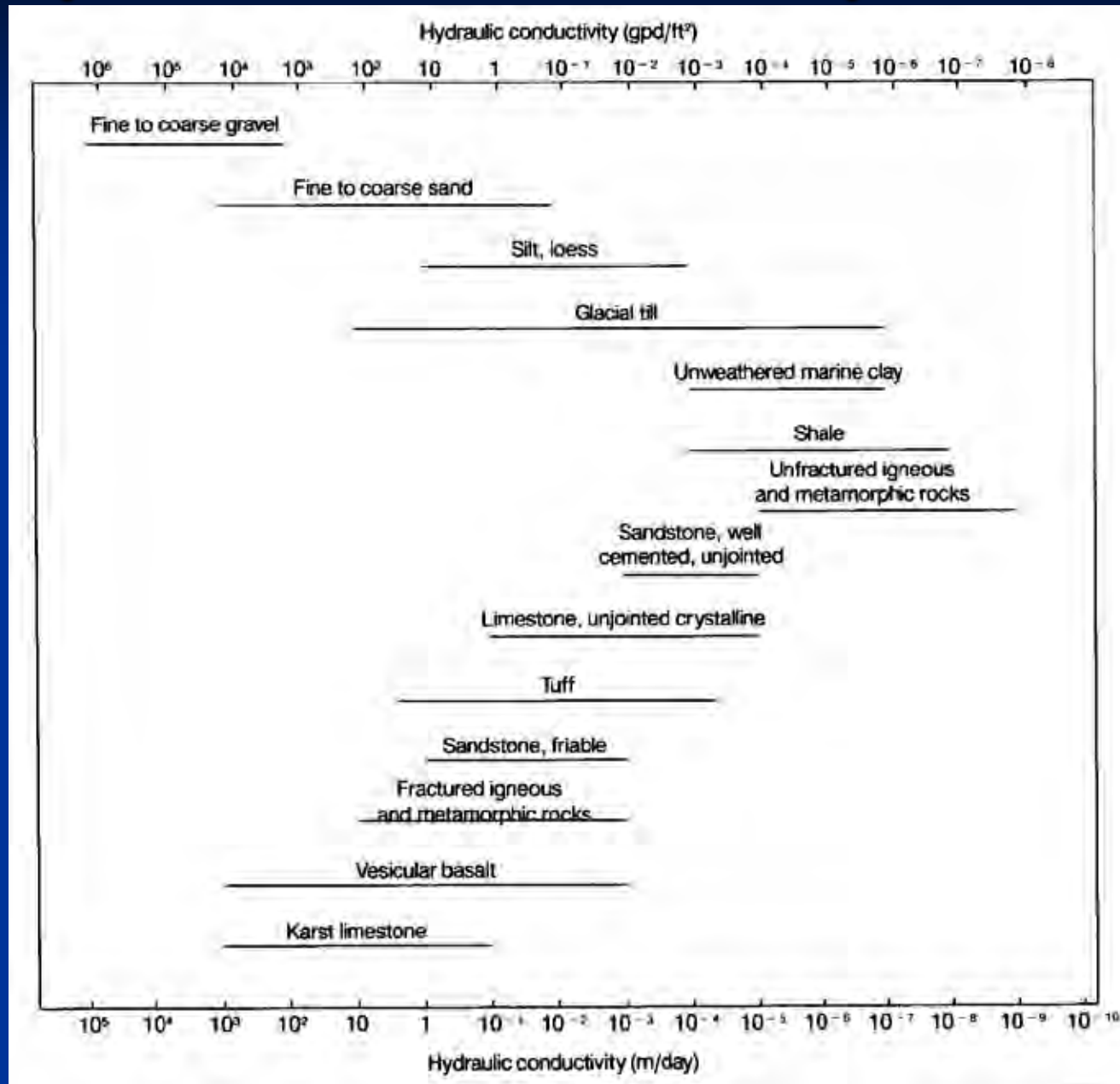

# Specific Yield Values

<b>Sediment</b>	<b>Specific Yield, %</b>
Clay	1-10
Sand	10-30
Gravel	15-30
Sand and Gravel	15-25
Sandstone	5-15
Shale	0.5- 5
Limestone	0.5- 5

# Determining Aquifer Flow

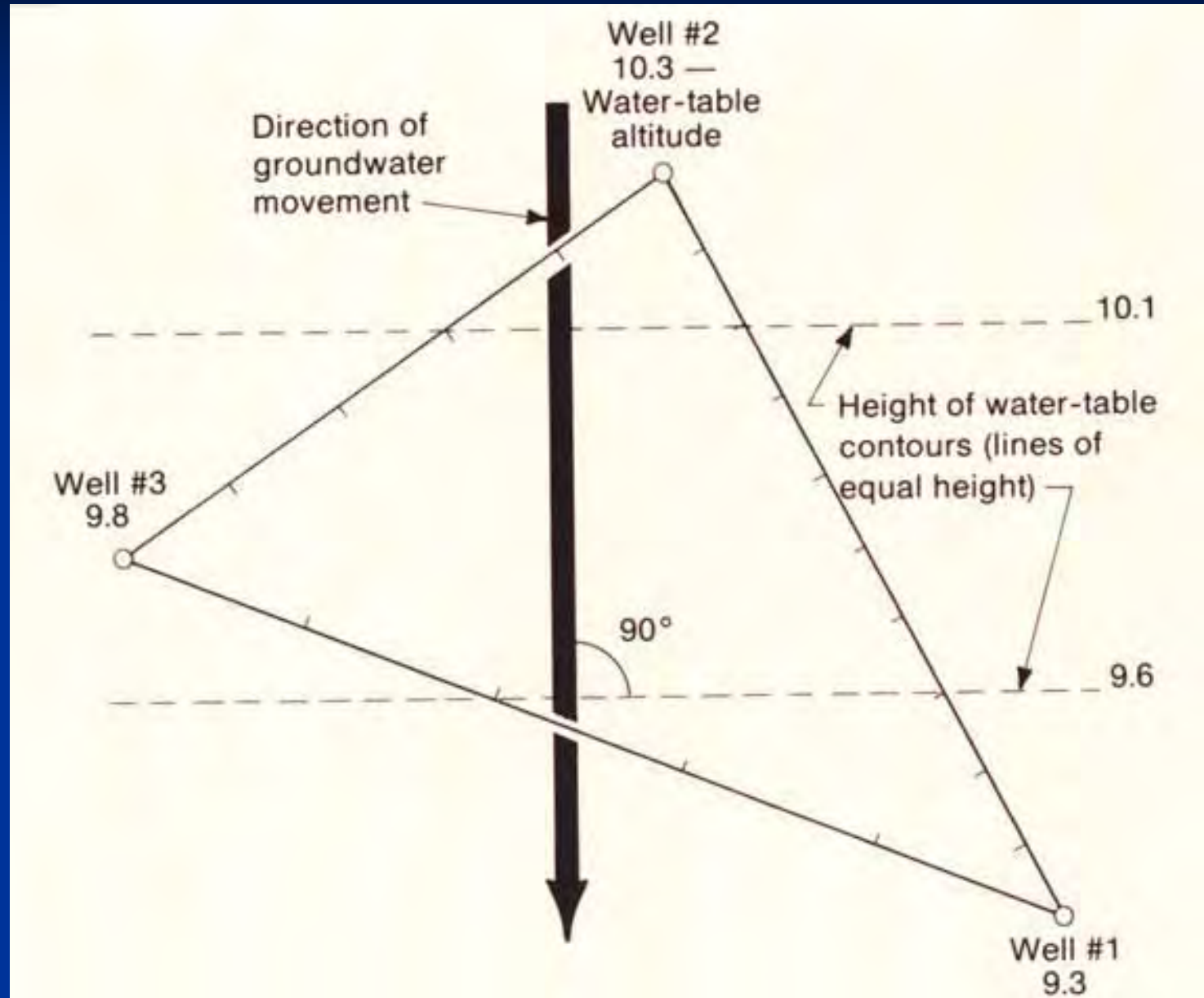



# Common Aquifer System

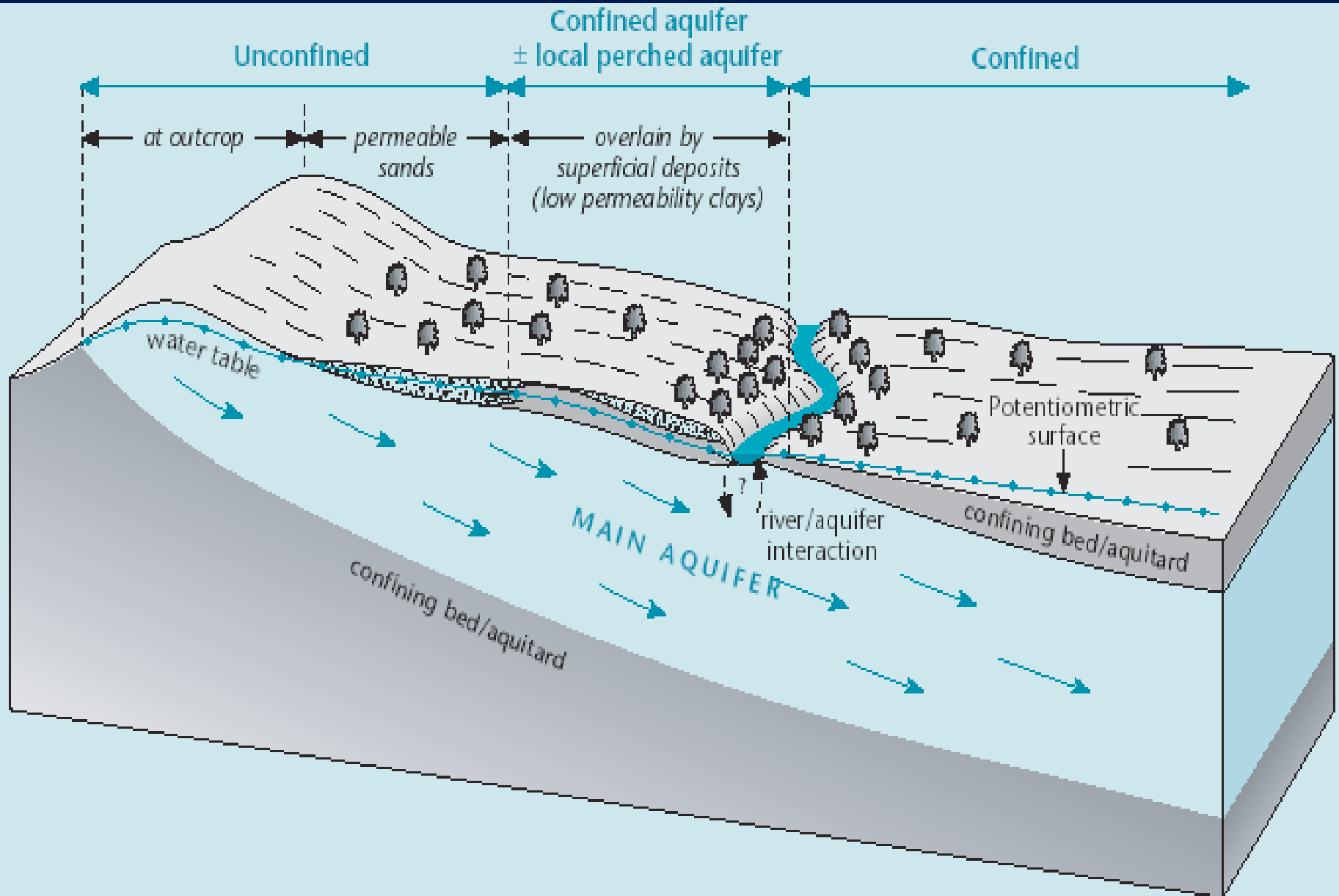

# Regional Aquifer Flow System

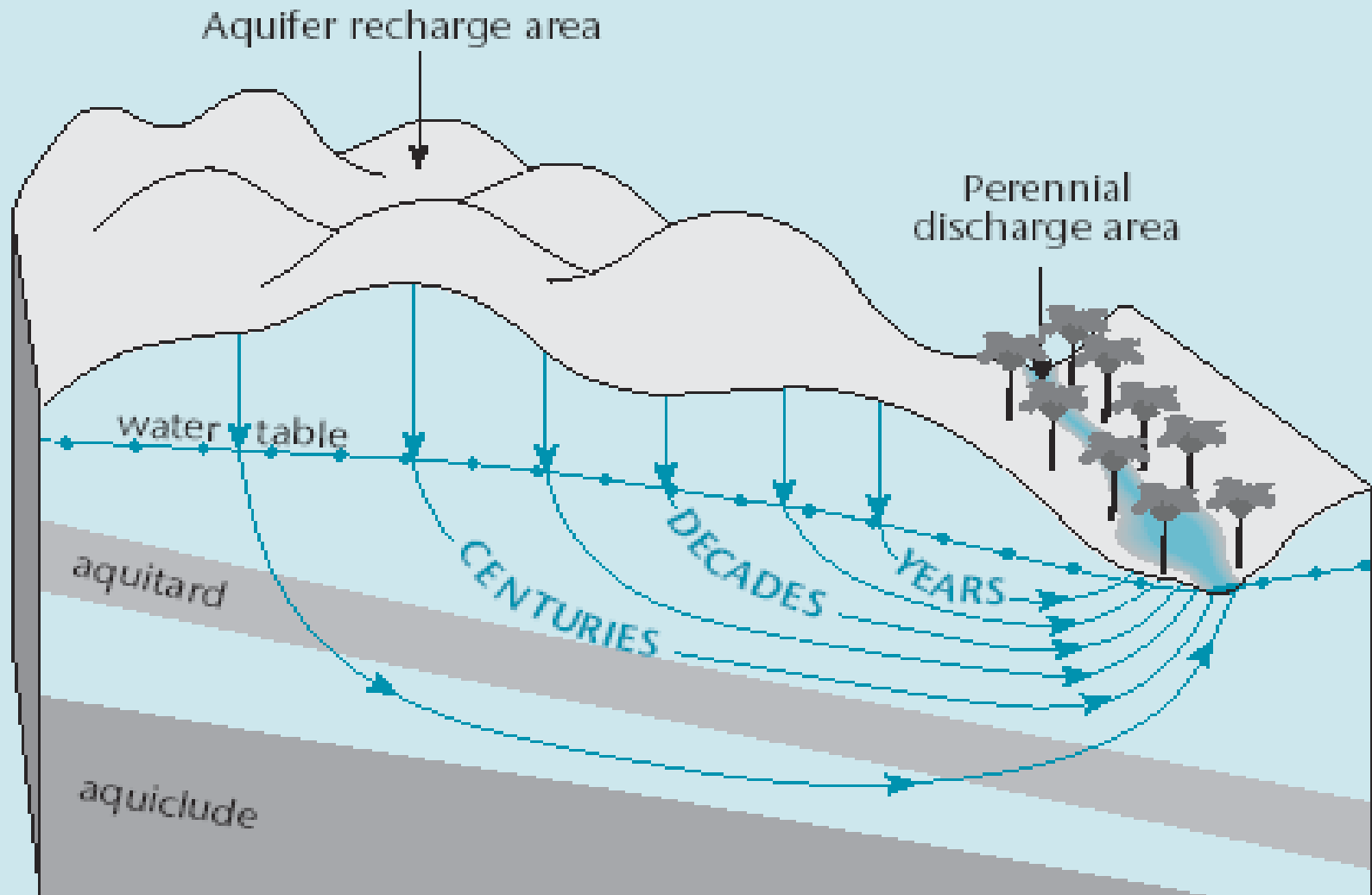

# Basic Groundwater Recharge & Discharge

Source: USGS circular 1174

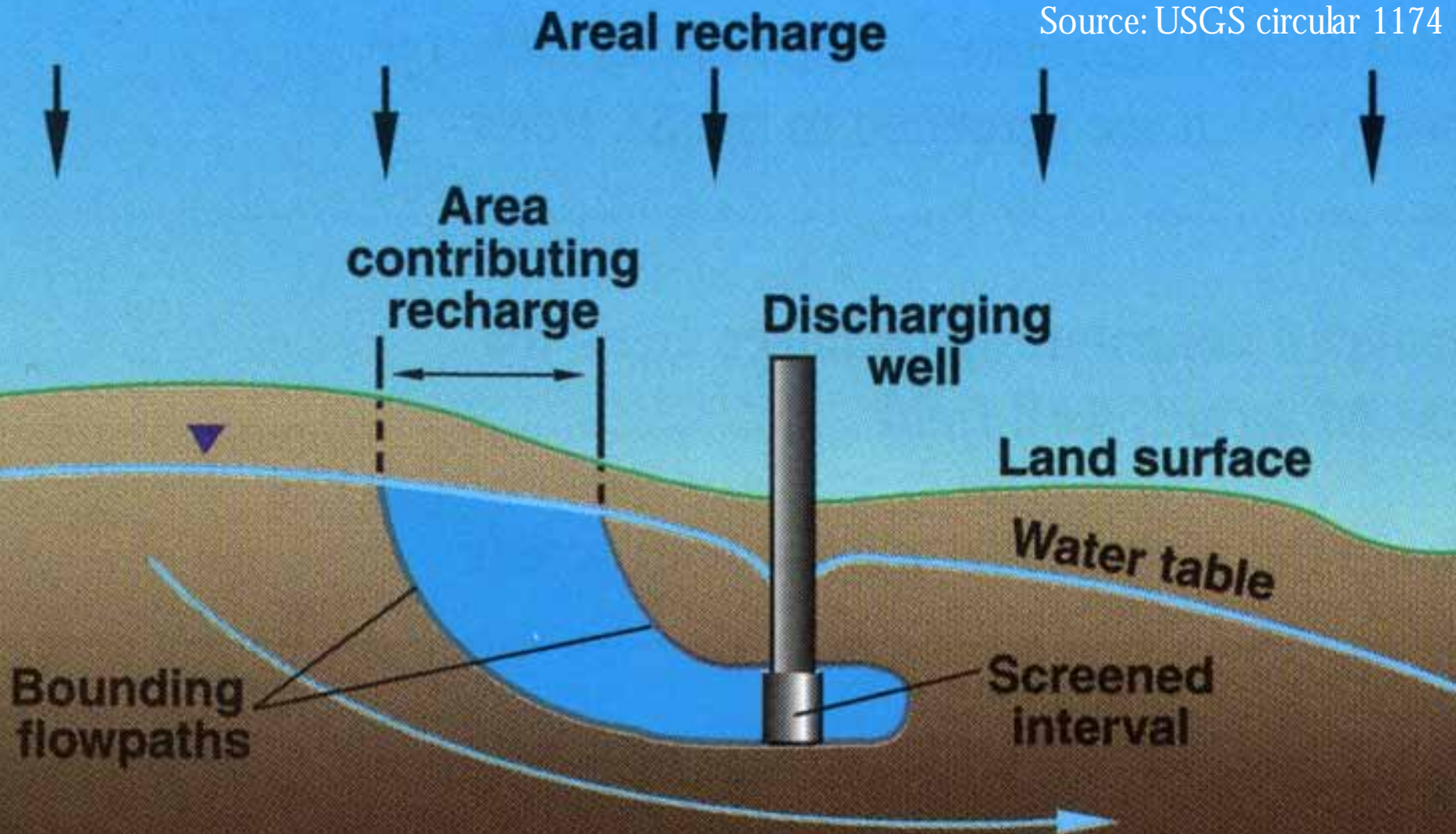

# Basic Recharge & Discharge Continued

Area of Contributing Recharge in 5 years

Source: modified from USGS circular 1174

Current Area Contributing to Recharge

Discharging Well

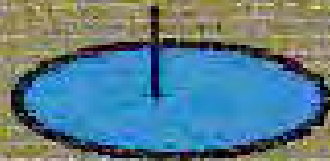
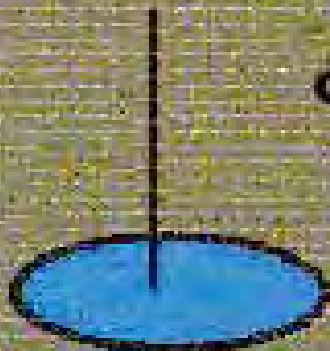

Overhead View



# Complex Recharge & Discharge

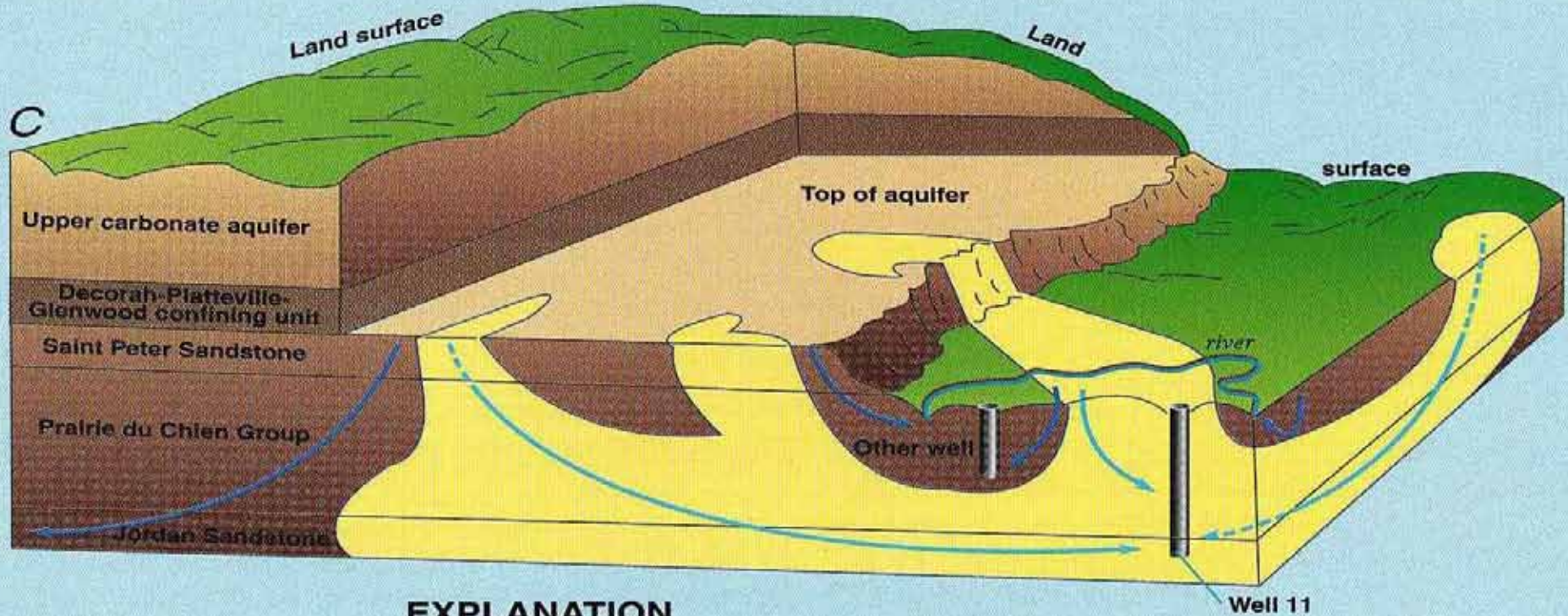

## EXPLANATION

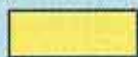

Model computed areas contributing recharge and subsurface volumes containing flowpaths that discharge to well 11



Ground-water flowpaths that discharge to well 11, dashed where flow is not along face of block diagram



Other ground-water flowpaths

# Basic Groundwater Quality

## Major constituents (greater than 5 mg/l)

Bicarbonate	Silicon
Calcium	Sodium
Chloride	Sulfate
Magnesium	

## Minor constituents (0.01-10.0 mg/l)

Boron	Nitrate
Carbonate	Potassium
Fluoride	Strontium
Iron	

## Trace constituents (less than 0.1 mg/l)

Aluminum	Bromide
Antimony	Cadmium
Arsenic	Cerium
Barium	Cesium
Beryllium	Chromium
Bismuth	Cobalt

Copper	Rubidium
Gallium	Ruthenium
Germanium	Scandium
Gold	Selenium
Indium	Silver
Iodide	Thallium
Lanthanum	Thorium
Lead	Tin
Lithium	Titanium
Manganese	Tungsten
Molybdenum	Uranium
Nickel	Vanadium
Niobium	Ytterbium
Phosphate	Yttrium
Platinum	Zinc
Radium	Zirconium

*(Davis and De Wiest, 1966)*



# Water Wells 101



# Types of Well Construction

- Cable Tool or Percussion Method
  - Impact created by raising and dropping a heavy drill bit
  - Cuttings are extracted with a bailer
- Rotary Drilled/Reverse Rotary Drilled
  - Power driven drill stems cut formation
  - Drilling mud is pumped down to cool the bit
  - Cuttings are brought to the surface via the casing or drill stem
- Air Rotary
  - Impact created by pneumatic air hammer
  - Cuttings are brought up to surface by air pressure



# Cable Tool Method

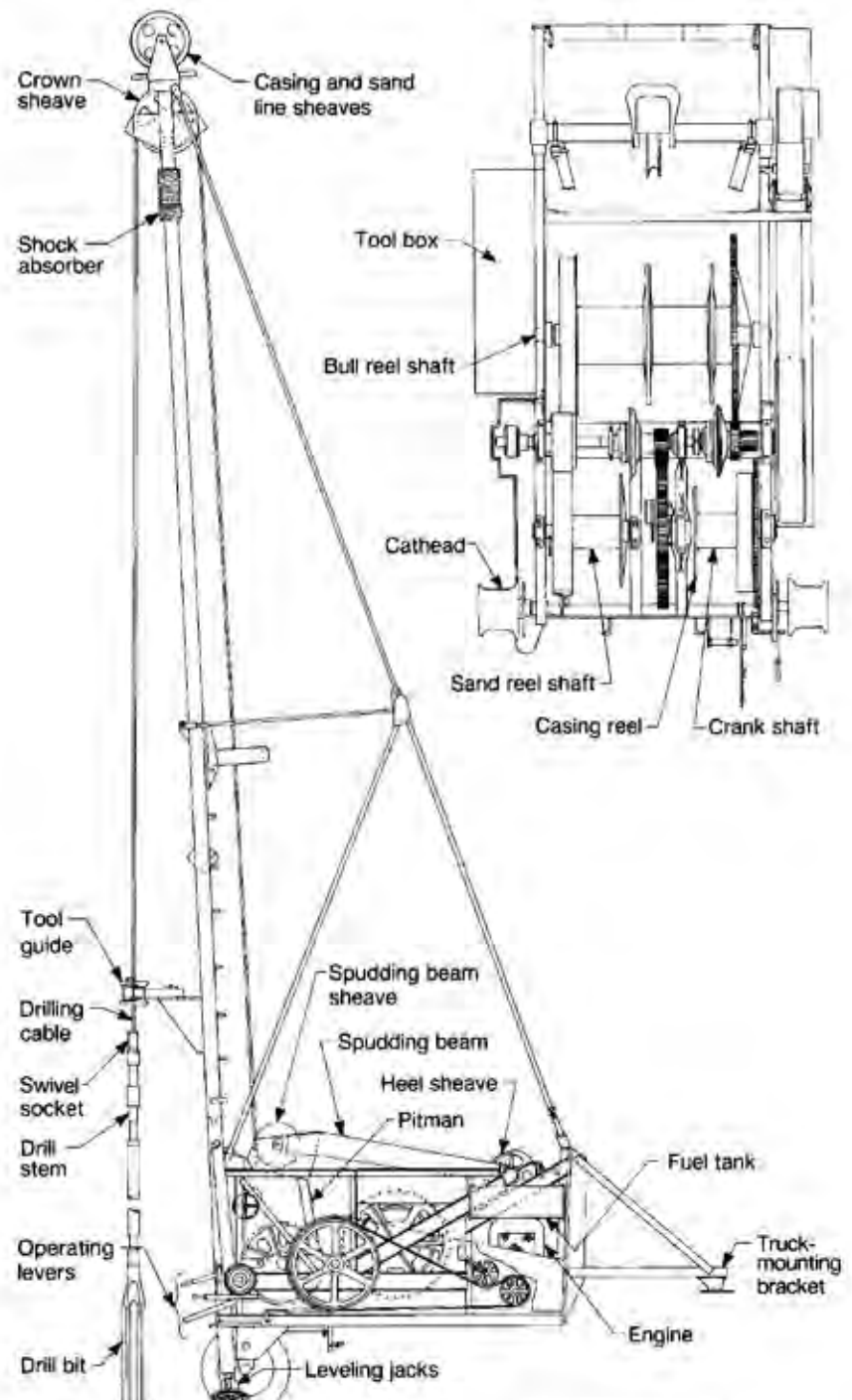

# Rotary Method

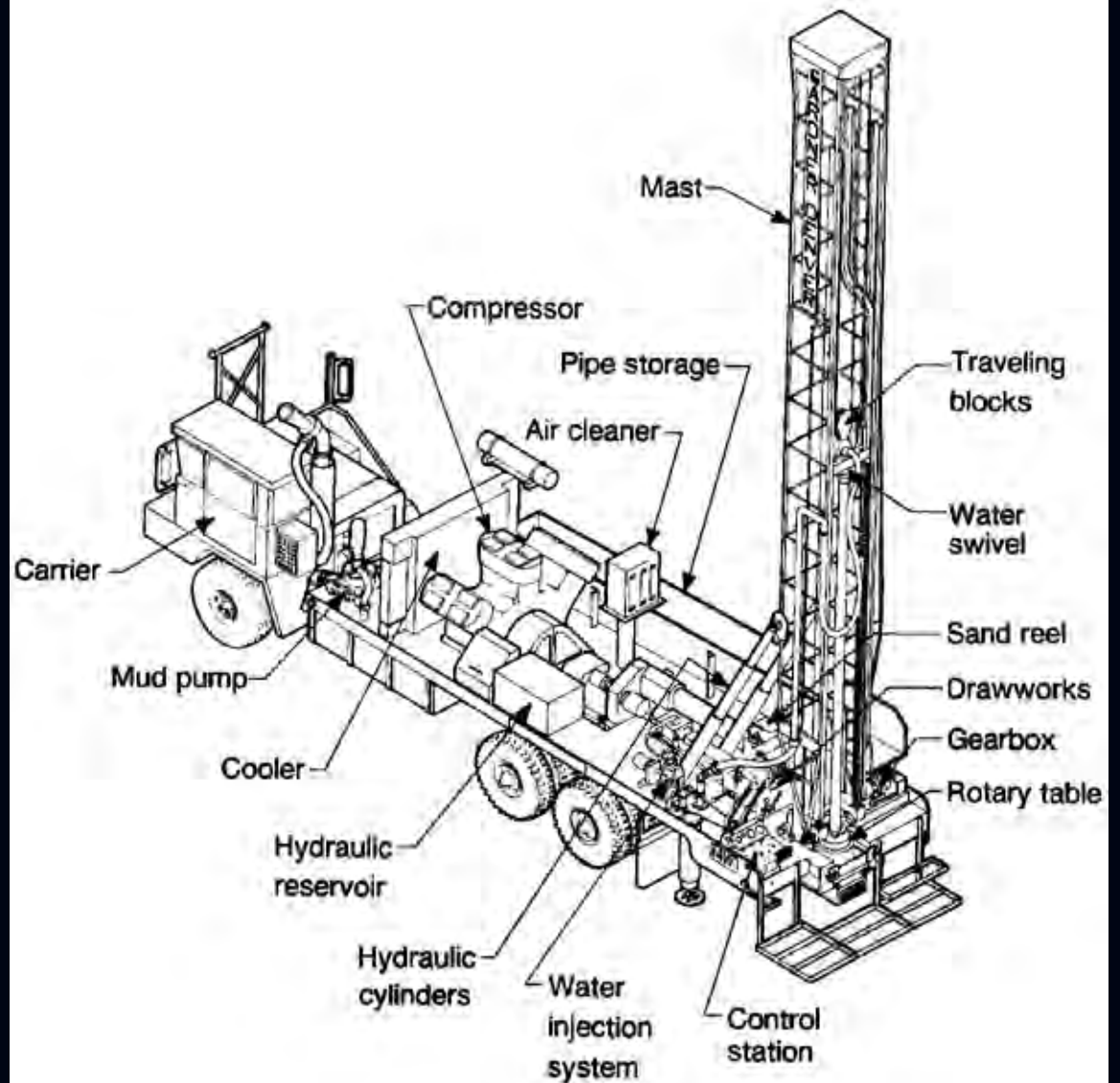

# Air Rotary Method



# Well Development

**Figure 1: General Resource Protection Well—Cross Section**

Surface Protective Measures  
(SEE WAC 173-160-510)

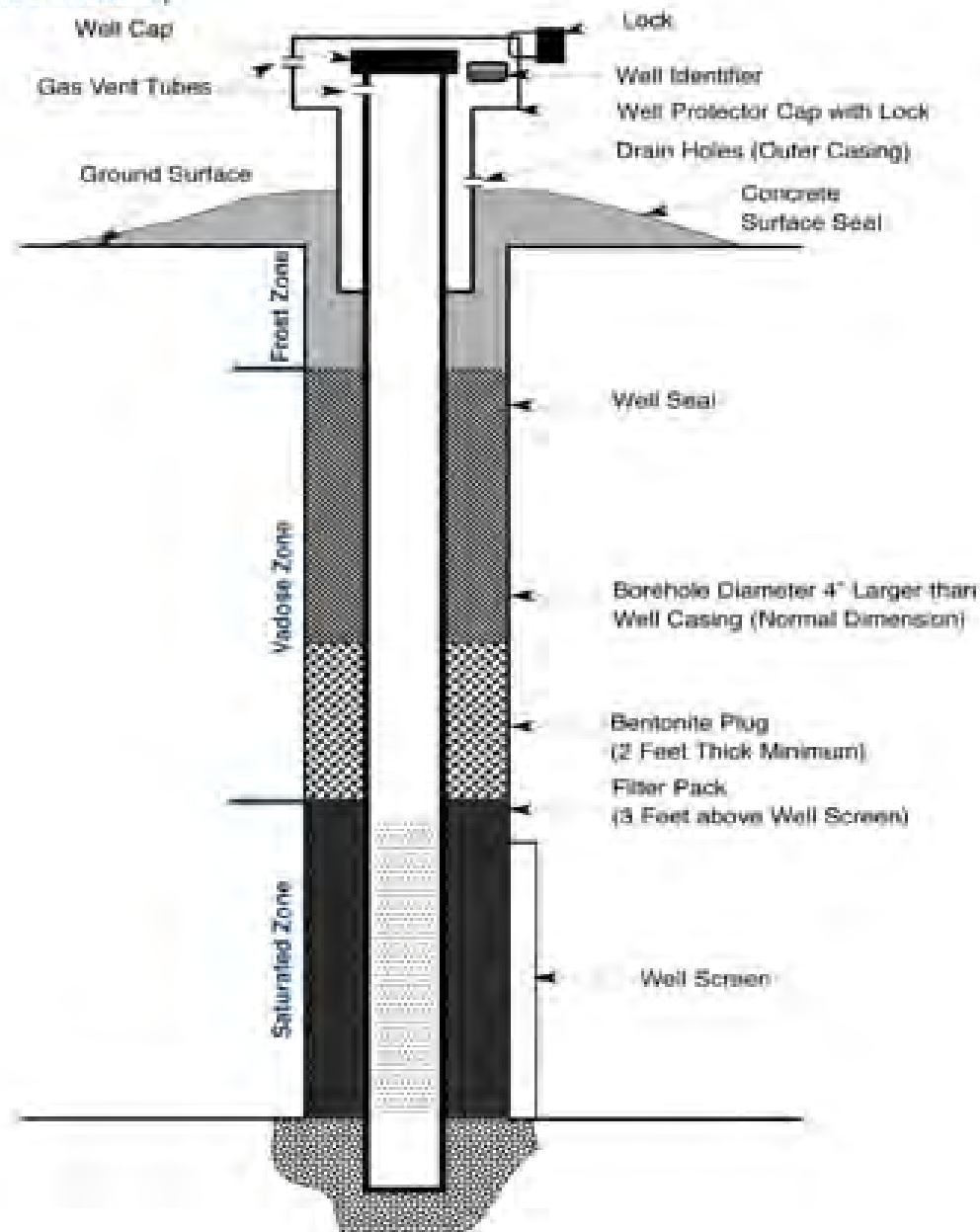

# Typical Water Well

# Typical Water Well

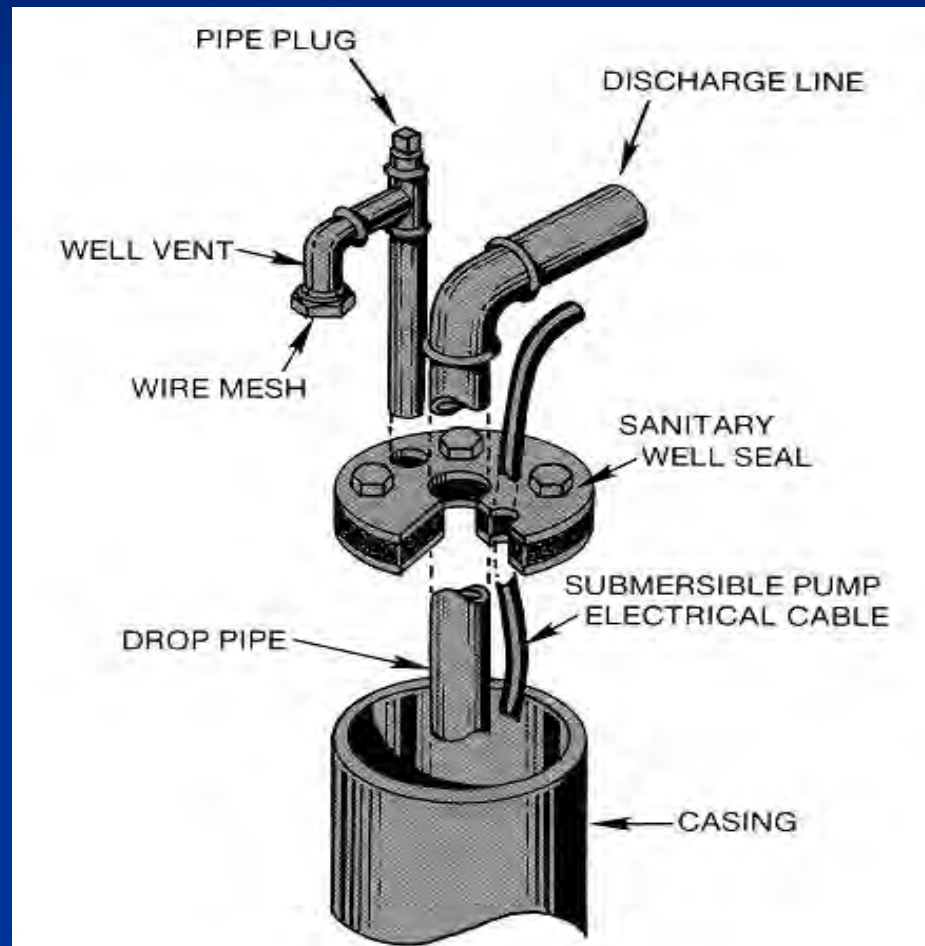
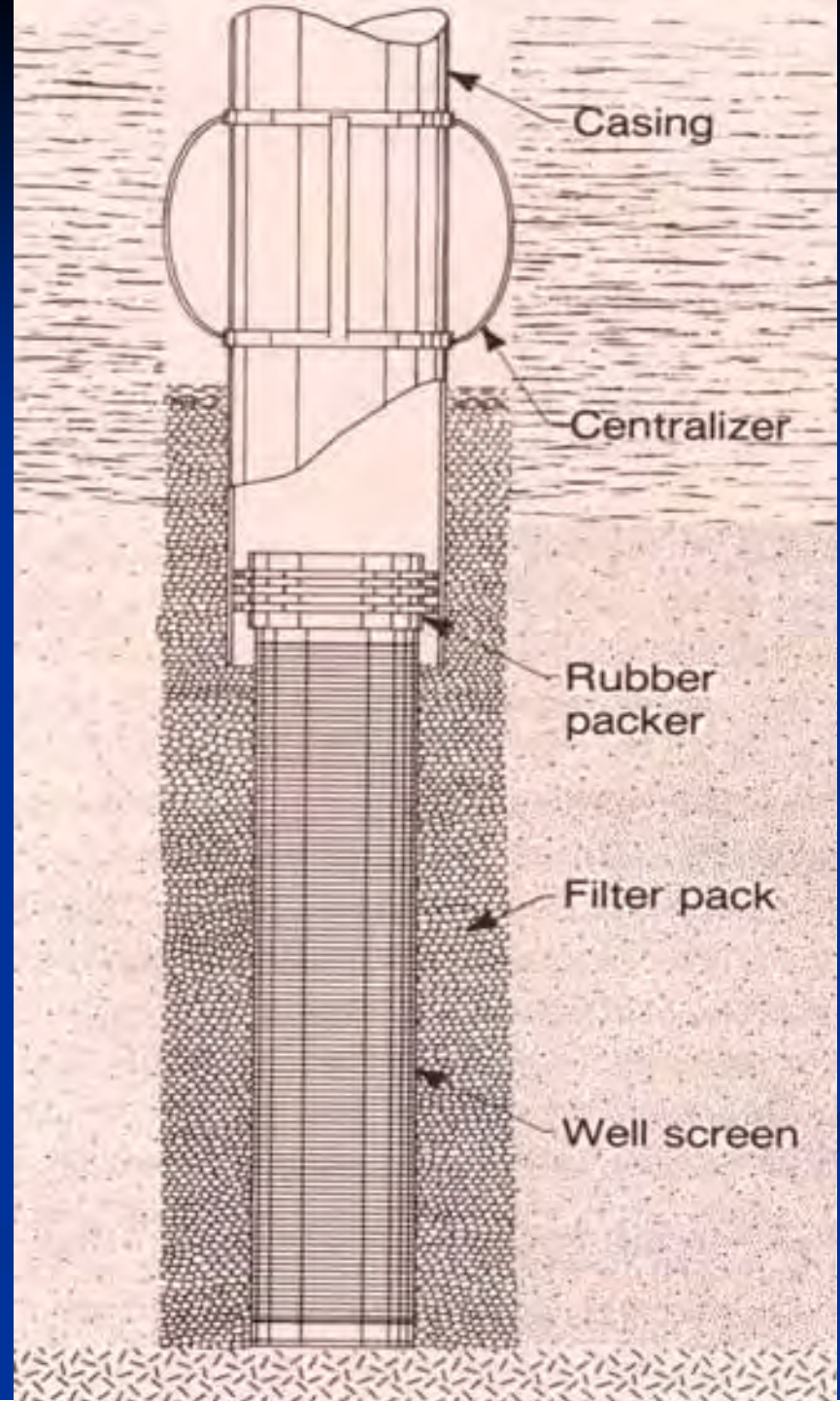

Figure 11 Sanitary Well Seal for Submersible Pump Installation



# Gravel Pack and Screens



# Well Screen and Slotted Casing





# Screen Variety

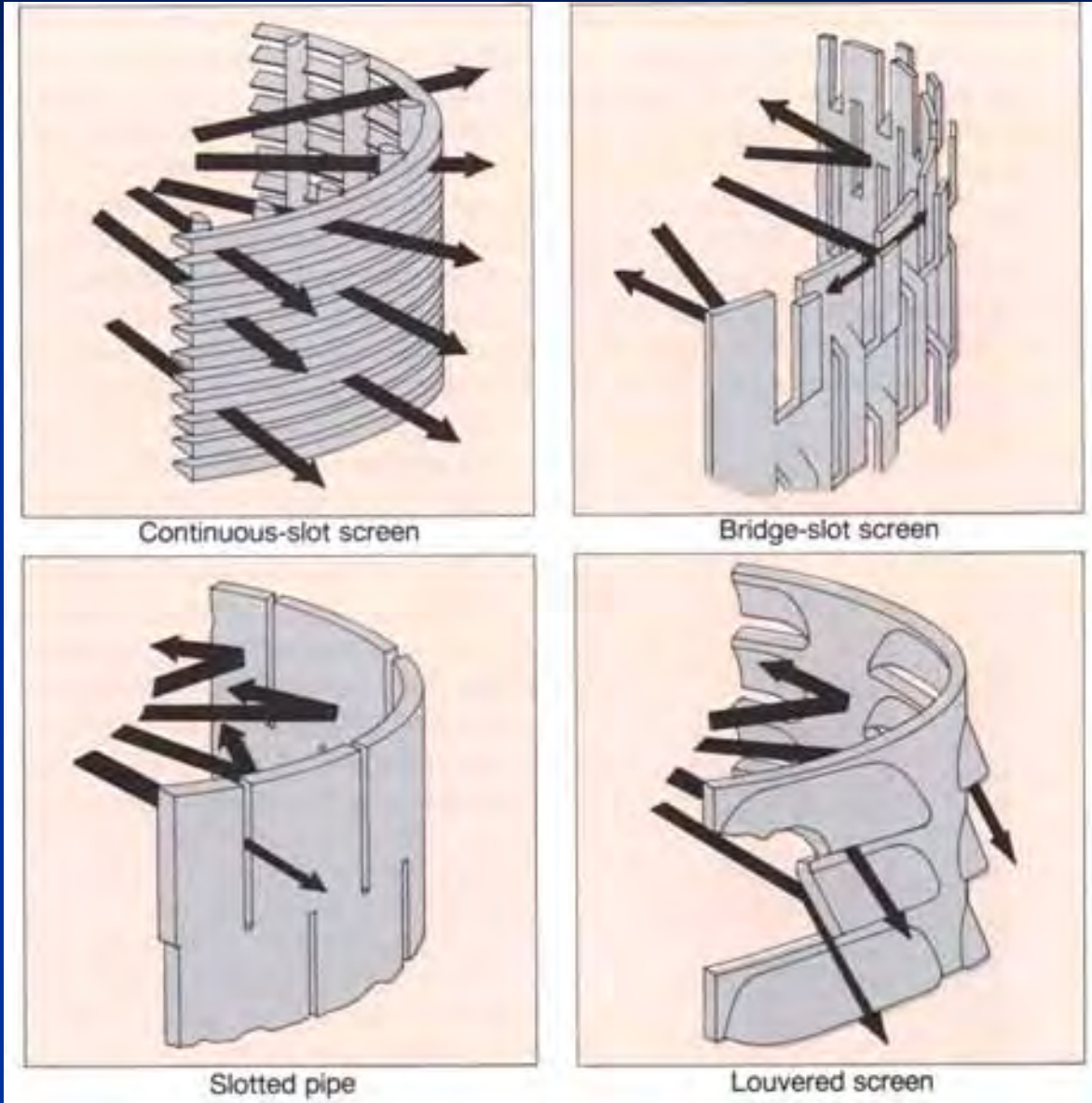

# Water Well Pumps

(Vertical Turbine Centrifugal Pumps)

- Discharges water out of the top of the impeller rather than at a right angle
- Two types of VTCPs
  - Line-shaft pump
  - Submersible pump

# Line Shaft VTCP

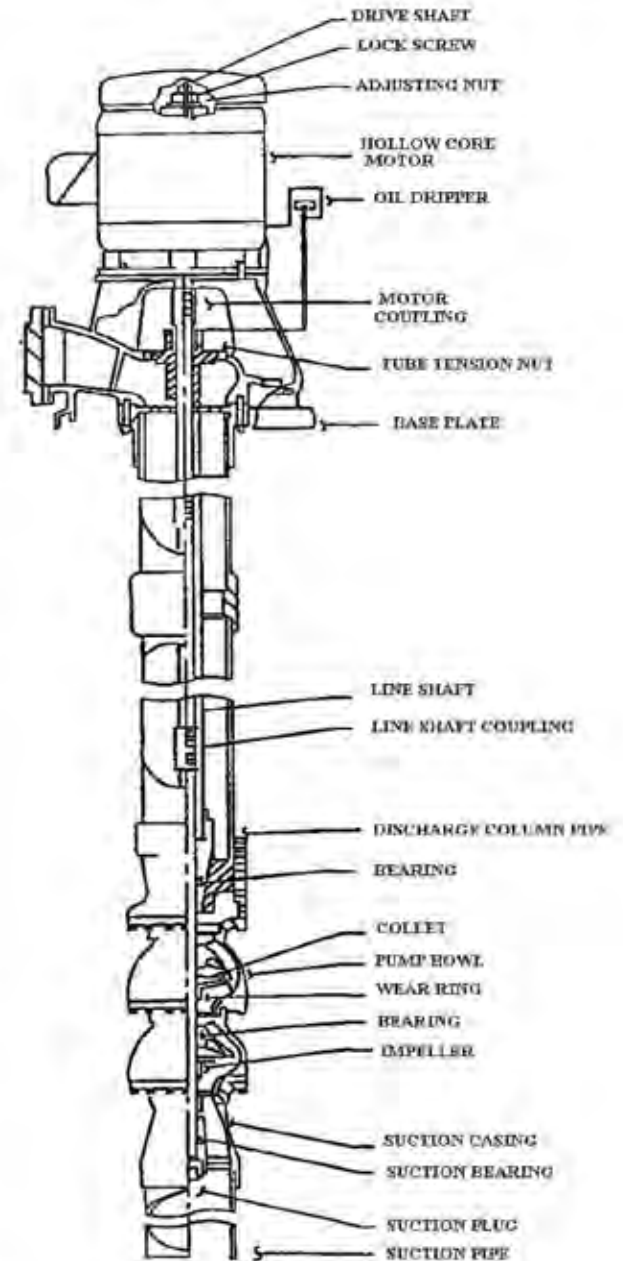

VERTICAL TURBINE CENTRIFUGAL PUMP

# Submersible VTCP

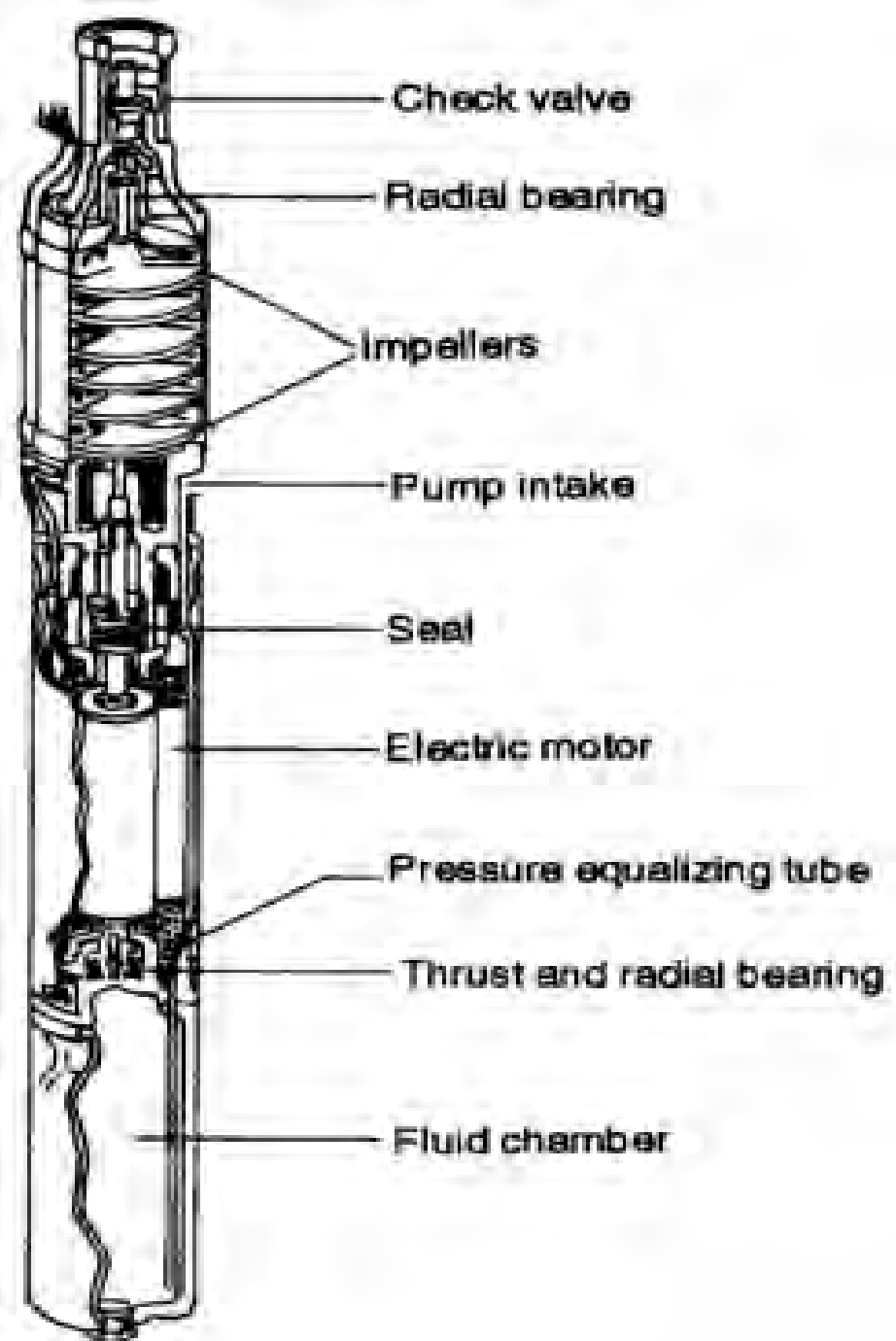

# Well Hydraulics

- n Static water level
- n Cone of depression
- n Drawdown
- n Pumping water level
- n Zone of capture (radius of influence)
- n Equilibrium
- n Specific capacity
- n Recovery Time



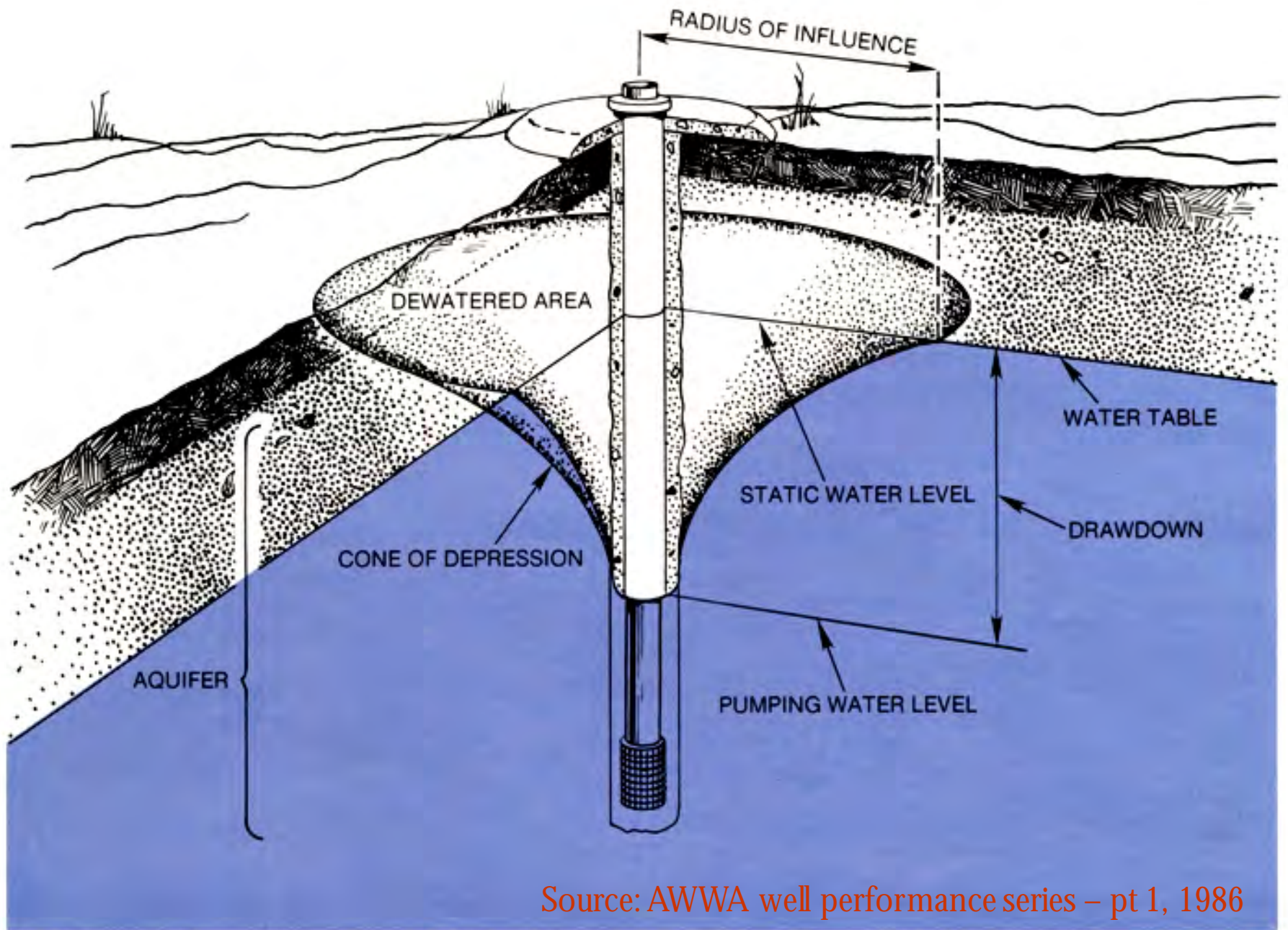

Source: AWWA well performance series – pt 1, 1986

Figure 5 Common Water Well Terms and Measurements

# Well and Pump Problems

# Contamination

# Pathways of

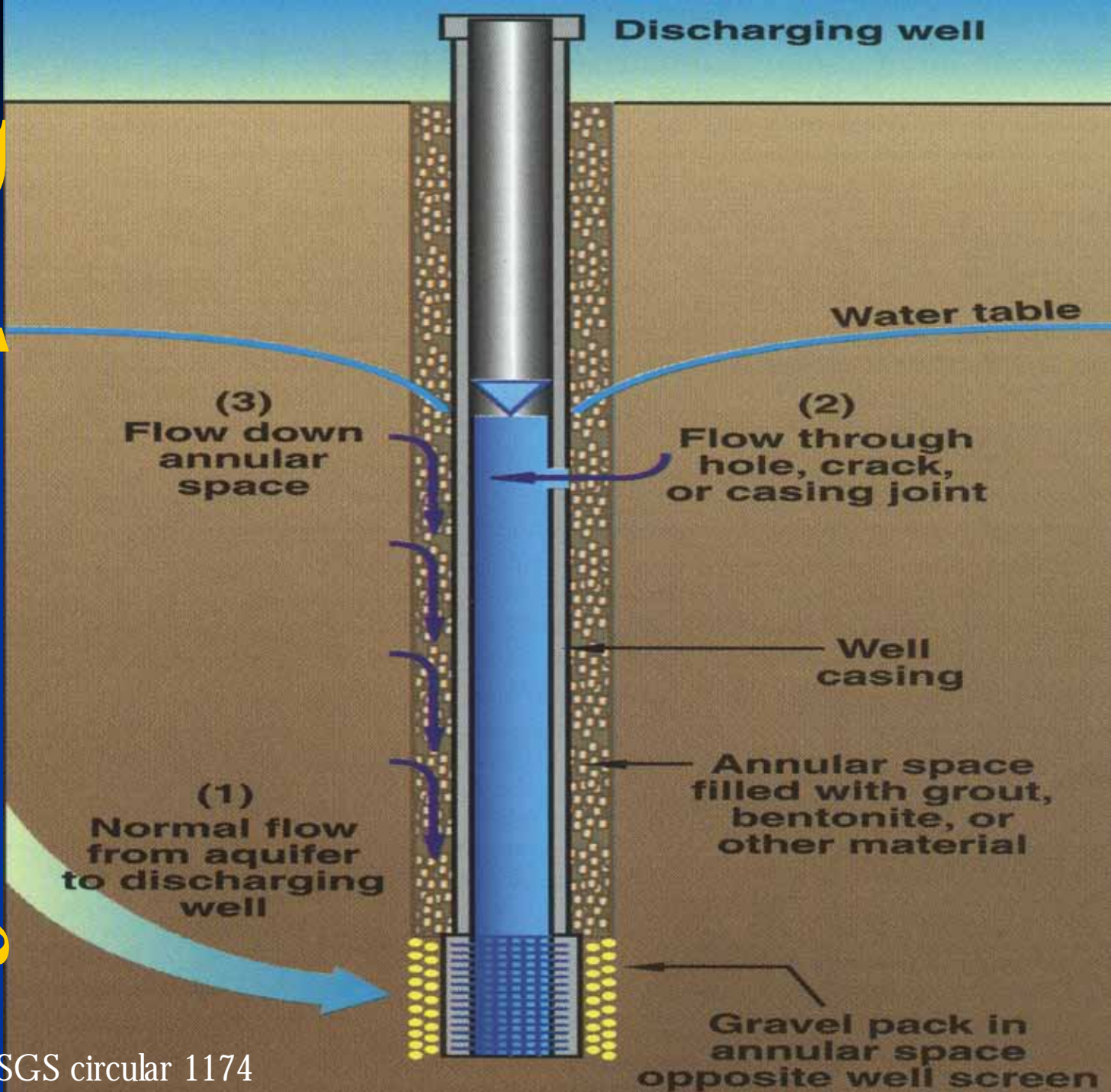



# Well Interference

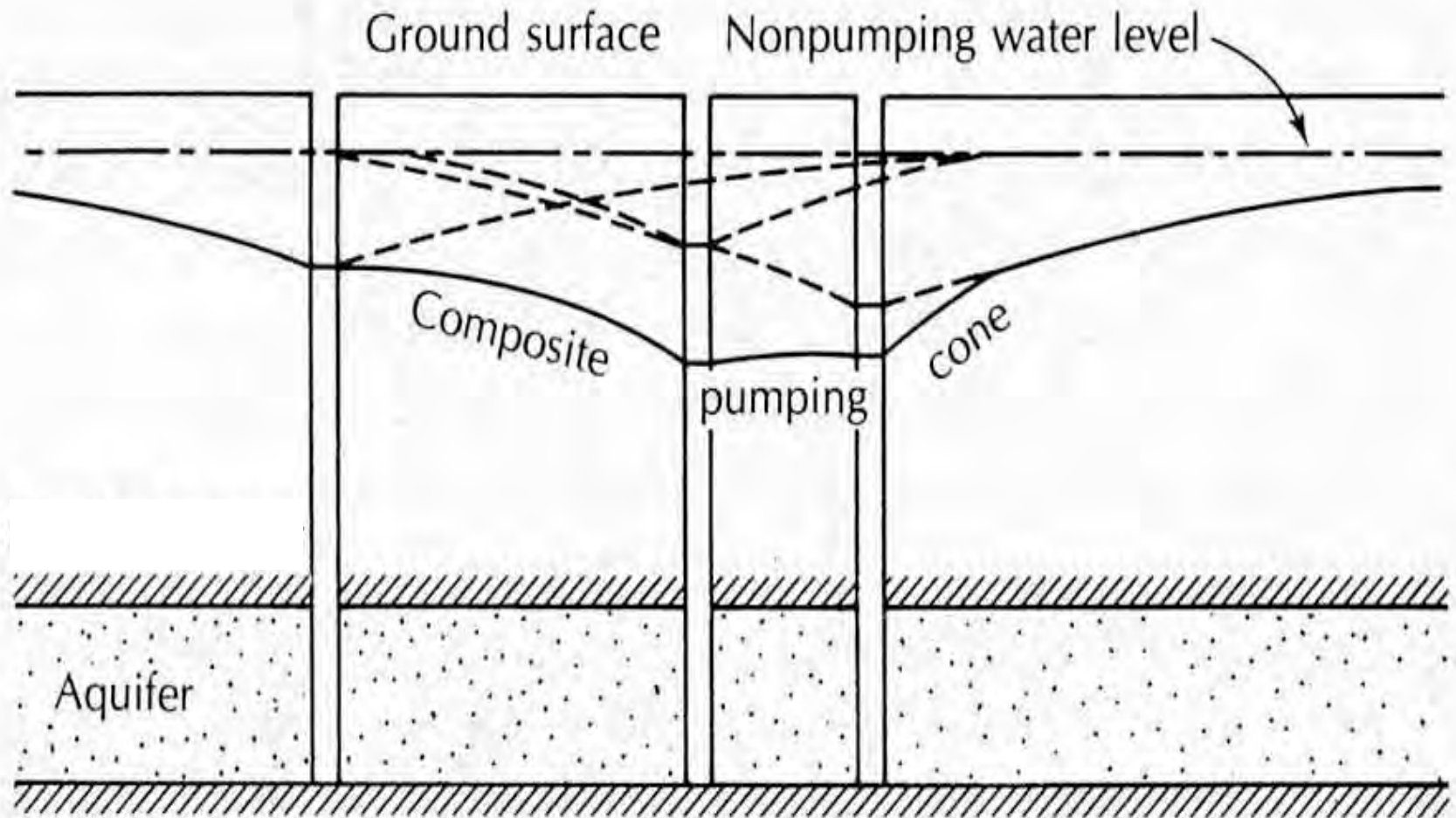

# Well Equilibrium

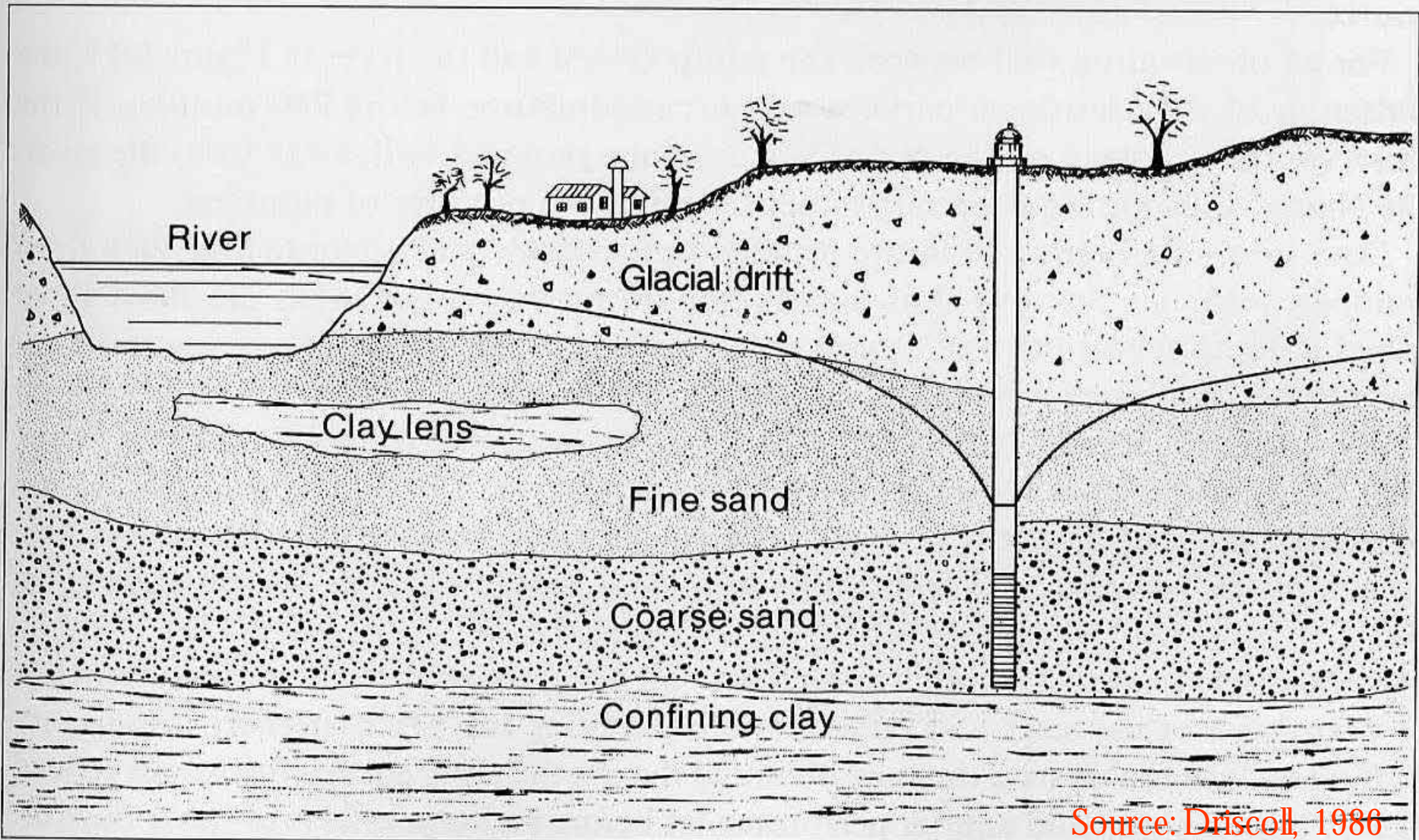



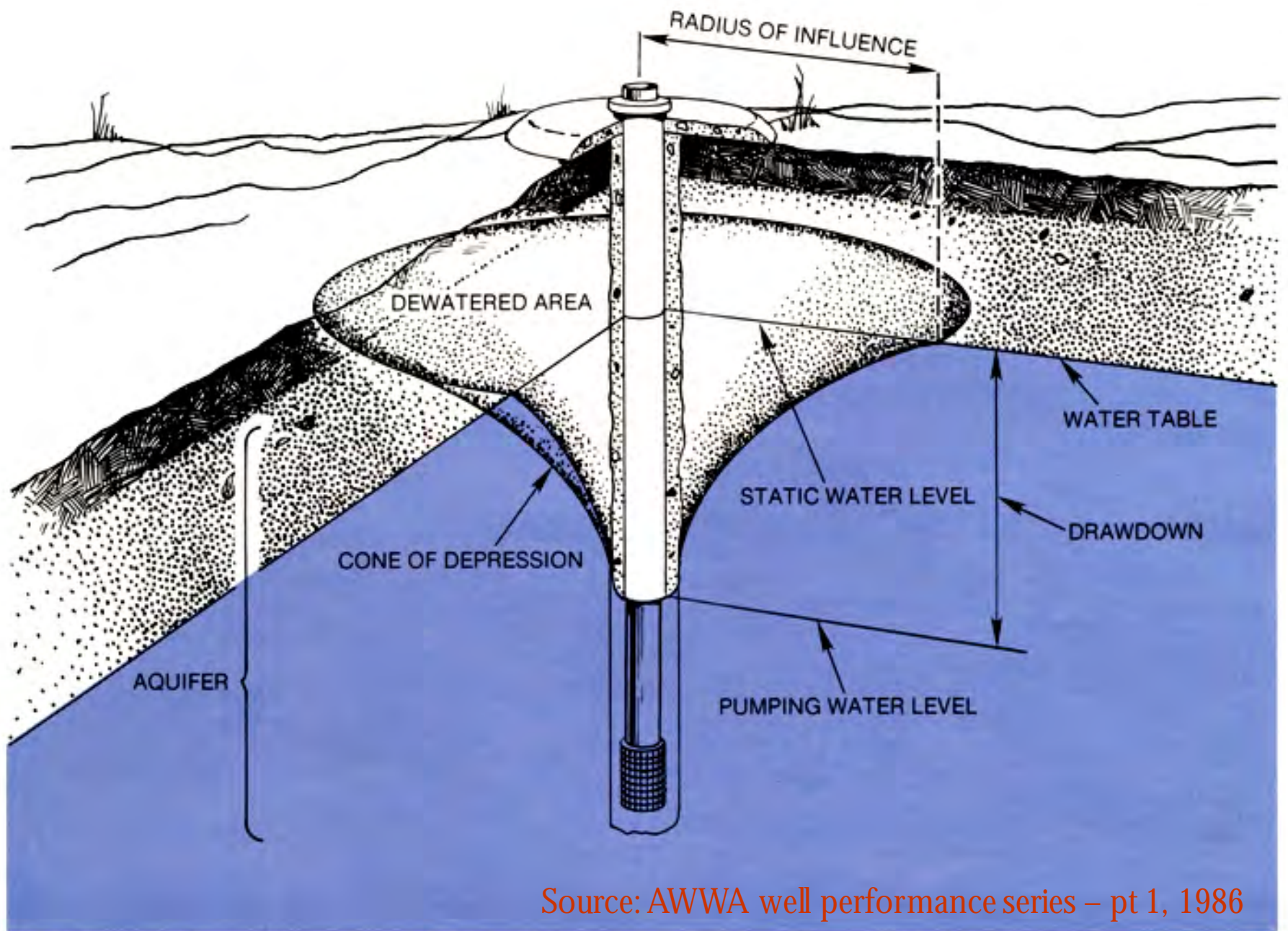

Source: AWWA well performance series – pt 1, 1986

Figure 5 Common Water Well Terms and Measurements

# Is it the well, pump, or aquifer?

## Problem

Static water level stays the same but the pumping level has dropped several feet:

Static water level is the same but pumping water level has risen several feet, pump production has also decreased:

## Issue

- Clogged Screens
  - Sand Bridging
  - Iron Bacteria
  - Lime Scaling
  
- Pump related problems
  - Impeller clearance
  - Line shaft stretch

**Questions???**

**Comments???**



**New Mexico Rural Water Association**

**3413 Carlisle Blvd NE**

**Albuquerque, NM 87110**

**1-800-819-9893**

**<http://www.nmrwa.org>**



**Tim Wellman**

**[tim@nmrwa.org](mailto:tim@nmrwa.org)**

***Providing technical assistance and training to  
water systems across New Mexico since 1978***