CHAPTER 7

CONTAMINANT FATE PROCESSES

JOSEPH B. HUGHES

7.1 INTRODUCTION

The distribution and concentrations of contaminants in ground water systems is strongly influenced by interactions between the contaminant and the physical, chemical, and biological components of the subsurface. Collectively, these interactions are referred to as **fate processes**. In some cases, fate processes result in the alteration of the contaminants chemical structure ultimately resulting in the formation of nonhazardous compounds. Other fate processes result in a phase change, without altering the compounds chemical structure. In either case, fate processes must be considered during the evaluation of contaminant transport to accurately describe or predict the behavior of contaminants in ground water systems.

7.2 SORPTION AND DESORPTION

Sorption is defined as the association of a dissolved or gaseous contaminant with a solid material. In ground water systems, the solid materials of interest are aquifer materials or soil, and typically the contaminants are present in the dissolved phase. Common terminology used to describe participants in the sorption processes are **sorbent** and **sorbate**. The sorbent is the solid material (i.e., aquifer material) to which the dissolved or gaseous sorbate (i.e., the contaminant) associates. The term sorption encompasses two more specific processes referred to as **adsorption** and **absorption**. Adsorption is the association of a contaminant with the surface of a solid particle. Absorption is the association of a contaminant within a solid particle. Often it is difficult to distinguish between adsorption and absorption, since both may be occurring simultaneously; hence sorption is typically used to describe the overall phenomena.

Sorption is an important process effecting the transport of contaminants in the subsurface and can significantly influence the ability to remediate contaminated sites. Since aquifer material is static, a molecule that is associated with the solid phase is not moving. This **retardation** of contaminant transport is an essential component of accurately assessing migration rates or the ability to extract contaminants with pump and treat systems. Furthermore, sorption must be considered to determine the mass of contaminants present at a contaminated site and can also influence the rates of biodegradation processes.

The reverse of sorption is **desorption** — a term that describes the dissociation of a sorbed molecule and its return to the aqueous or gaseous phase. Interestingly, the observed behavior of desorption processes (i.e., rate and extent) may not be the reverse of the observed behavior of the sorption process (this will be discussed in more detail later in this section). It is important to recognize this distinction, as we will focus the discussion on a description of contaminant sorption and generally assume reversibility.

7.2.1 Factors That Influence Sorption

A simplistic way of describing sorption is the saying "like likes like." In more precise terminology, molecules tend to associate with other molecules that have similar properties. An analogy to this is solubility. Nonpolar molecules are more soluble in nonpolar solvents than in polar solvents, and ionic or polar molecules are more soluble in polar solvents than in nonpolar solvents. In the case of sorption, hydrophobic contaminants interact primarily with hydrophobic constituents of aquifer solids, while ionic or polar materials interact with charged mineral surfaces. In either case, the extent to which sorption may occur is influenced by the chemical properties of both the sorbent and the sorbate (see Figure 7.1).

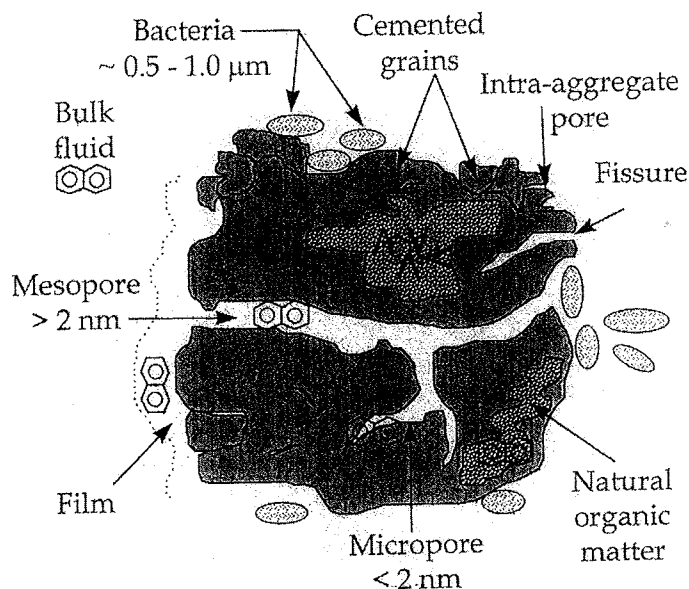

Figure 7.1 Schematic of soil grain sorption.

Unfortunately, soils and aquifer solids are complex materials that may support a range of sorption interactions (Schwartzbach, et al., 1993; Weber and DiGiano, 1996). An individual soil grain is an extraordinarily heterogeneous composite containing minerals and natural organic matter. The mineral surfaces are dominated by polar or ionic functional groups capable of interacting with polar or ionic contaminants. The natural organic matter is generally **hydrophobic** material that tends to exclude water and other highly polar molecules (hydrophobic literally means water fearing). This fraction of soil or aquifer solids occurs typically where nonpolar/hydrophobic molecules associate.

If one considers the most common organic contaminants found in the subsurface, most are hydrophobic compounds. Examples of chemicals that exhibit this behavior include petroleum hydrocarbons (including benzene, toluene, ethylbenzene, and xylenes), chlorinated solvents (including TCE, PCE, CT, hexachlorobutadiene, and others), polychlorinated biphenyls (PCBs), and polynuclear aromatic hydrocarbons (PAHs) (see Chapter 4 for descriptions of these compounds). In all cases, the sorption of these compounds with soils or aquifer solids is primarily through the association with the natural organic matter fraction of the solid phase – simplifying the analysis of sorption in most cases (Chiou, et al., 1979).

The most accepted method of evaluating the propensity of an individual contaminant to associate with the organic fraction of aquifer solids is the **octanol-water partition test** (Briggs, 1973; Brown, et al., 1981). In this evaluation, octanol serves as a surrogate material for natural organic matter. Briefly, the test is conducted in a test tube containing equal volumes of octanol and water. Since octanol is immiscible in water, a two-phase system exists in the tube (similar to what occurs when olive oil is added to water). The contaminant is

added to the tube and allowed to equilibrate between the two phases. After equilibration, the concentration of both phases is determined and the ratio of their concentrations is referred to as the **octanol-water partition coefficient** (k_{ow}). The mathematical definition of k_{ow} is presented in Eq. (7.1), where $[A]$ represents the concentration of the contaminant in either phase.

$$k_{ow} = \frac{[A]_{\text{octanol}}}{[A]_{\text{water}}} \quad (7.1)$$

If the k_{ow} is less than 1, then the contaminant "prefers" the water phase, and would not associate extensively with natural organic matter. For most common ground water contaminants, the k_{ow} is greater than 1 and association with natural organic matter becomes an important process. In fact, many common contaminants have k_{ow} in excess of 100, some as high as 1×10^6 , indicating that common organic contaminants are highly attracted to a hydrophobic phase and will associate strongly with the natural organic fraction of soils or aquifer materials. The k_{ow} of common environmental contaminants are included in Table 7.1.

7.2.2 Equilibrium Evaluation Of Sorption — The Partition Coefficient

In order to calculate the migration rates of contaminants, or the total mass of contaminants present, the distribution of a contaminant between either the aqueous or solid phase must be established. This can become rather complicated if the kinetics of sorption must be considered. Fortunately, the association of hydrophobic contaminants with soil organic matter is usually fast when compared to the duration of contact between contaminants and aquifer solids at contaminated sites. Thus, local equilibrium conditions often exist.

The most common approach for evaluating a contaminant's distribution between the solid and aqueous phase is through the development of a **partition coefficient** (k_d), which is defined in Eq. (7.2) where $[A]$ is the concentration of a contaminant in either phase.

$$k_d = \frac{[A]_{\text{solid}}}{[A]_{\text{aqueous}}} \quad (7.2)$$

This is a test analogous to the octanol-water partition test, where aquifer solids are used instead of octanol, and the test is conducted over a range of contaminant concentrations. The result of this test is an **isotherm**, as depicted in Figure 7.2, where concentrations of solid phase contaminant concentration are plotted against the equilibrium aqueous phase contaminant concentration. In the figure presented, the observed relationship is linear, and the k_d can be obtained through a simple linear regression of the data. There are more complicated cases where a linear result is not obtained. If however, the primary association is a hydrophobic

TABLE 7.1 Properties for Selected Organic Compounds

Compound/ Family	Formula	Specific Gravity	Solubility (mg/L)	K_{ow}	Vapor Pressure (mm Hg)	Henry's Law (unitless)
Fuels and derivatives						
Benzene	C_6H_6	0.879	1750	130	60	0.22
Ethylbenzene	C_8H_{10}	0.867	152	1400	7	0.32
Phenol	C_6H_6O	1.071	93,000	29	0.2	1.89×10^{-6}
Toluene	$C_6H_5CH_3$	0.866	535	130	22	0.26
o-Xylene	$C_6H_4(CH_3)_2$	0.880	175	890	5	0.22
PAHs						
Acenaphthene	$C_{12}H_{10}$	1.069	3.42	10,000	0.01	0.321
Benzopyrene	$C_{20}H_{12}$	1.35	0.0012	1.15×10^6	—	5.8×10^{-8}
Benzoperylene	$C_{22}H_{12}$	—	0.0007	3.24×10^6	—	5.8×10^{-6}
Naphthalene	$C_{10}H_8$	1.145	32	2800	0.23	4.9×10^{-2}
Methyl naphthalene	$C_{10}H_7CH_3$	1.025	25.4	13,000	—	0.0164
Ketones						
Acetone	CH_3COCH_3	0.791	inf	0.6	89	0.00104
Methyl ethyl ketone	$CH_3COCH_2CH_3$	0.805	2.68×10^5	1.8	77.5	0.00181
Halogenated aromatics						
Chlorobenzene	C_6H_5Cl	1.106	466	690	9	0.165
2-Chlorophenol	C_6H_4ClOH	1.241	29,000	15	1.42	7.4×10^{-4}
p-Dichlorobenzene (1,4)	$C_6H_4Cl_2$	1.458	79	3900	0.6	0.067
Hexachlorobenzene	C_6Cl_6	2.044	0.006	1.7×10^5	1×10^{-5}	0.062
Pentachlorophenol	C_6OHCl_5	1.978	14	1.0×10^5	1×10^{-4}	1.5×10^{-4}
1,2,4-Trichlorobenzene	$C_6H_3Cl_3$	1.446	30	20,000	0.42	0.059
2,4,6-Trichlorophenol	$C_6H_2Cl_3OH$	1.490	800	74	0.012	—

Specific gravity at various temperatures; refer to Nyer and others (1991) for details; inf is infinite solubility
 Vapor pressure about 20 °C; 1 atm = 760 mm Hg.
 Modified from Nyer and others (1991). Reprinted by permission of Ground Water Monitoring Review Copy-
 right © 1991. All rights reserved.

TABLE 7.1 Properties for Selected Organic Compounds (continued)

Compound/ Family	Formula	Specific Gravity	Solubility (mg/L)	K_{ow}	Vapor Pressure (mm Hg)	Henry's Law Constant (unitless)
PCBs						
Aroclor 1254		1.5	0.012	1.07×10^6	7.7×10^{-6}	—
Halogenated aliphatics						
Bromodichloromethane	CHBrCl ₂	2.006	4400	76	50	8.53
Bromoform	CHBr ₃	2.903	3010	250	4	0.025
Carbon tetrachloride	CCl ₄	1.594	757	440	90	1.25
Chloroform	CHCl ₃	1.49	8200	93	160	1.41
Chloroethane	CH ₃ CH ₂ Cl	0.903	5740	35	1000	.212
1,1-Dichloroethane	C ₂ H ₄ Cl ₂	1.176	5500	62	180	0.64
1,2-Dichloroethane	C ₂ H ₄ Cl ₂	1.253	8520	30	61	0.05
1,1-Dichloroethene	C ₂ H ₂ Cl ₂	1.250	2250	69	495	—
cis-1,2-Dichloroethene	C ₂ H ₂ Cl ₂	1.27	3500	5	206	1.33
trans-1,2-Dichloroethene	C ₂ H ₂ Cl ₂	1.27	6300	3	265	0.221
Hexachloroethane	C ₂ Cl ₆	2.09	50	39,800	0.4	—
Methylene chloride	CH ₂ Cl ₂	1.366	20,000	19	362	0.13
1,1,2,2-Tetra- chloroethane	CHCl ₂ CHCl ₂	1.600	2900	250	5	0.083
Tetrachloroethene	CCl ₂ CCl ₂	1.631	150	390	14	1.21
1,1,1-Trichloroethane	CCl ₃ CH ₃	1.346	1500	320	100	0.72
1,1,2-Trichloroethane	CH ₂ ClCHCl ₂	1.441	4500	290	19	0.031
Trichloroethene	C ₂ HCl ₃	1.466	1100	240	60	0.42
Vinyl chloride	CH ₂ CHCl	0.908	2670	24	266	3.58
Other						
2,6-Dinitrotoluene	C ₆ H ₃ (NO ₂) ₂ CH ₃	1.283	1320	100	—	—
1,4-Dioxane	C ₄ H ₈ O ₂	1.034	4.31×10^5	1.02	30	—
Nitrobenzene	C ₆ H ₅ NO ₂	1.203	1900	71	0.15	9.3×10^{-4}
Tetrahydrofuran	C ₄ H ₈ O	0.888	0.3	6.6	131	—

inter
of th
gene
mailatic
kg/l
mg/
tami
the
imp
fract
mas[A]_w
V_w a

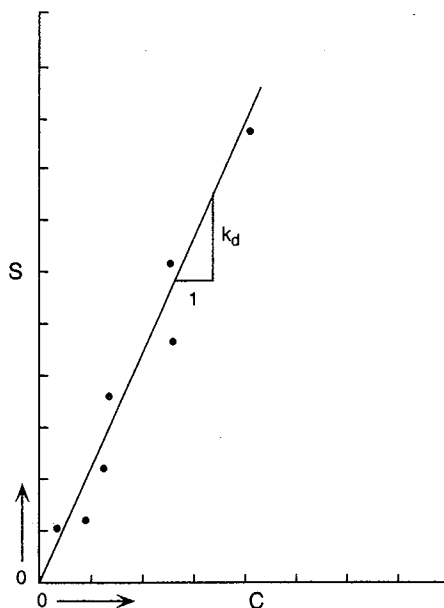

Figure 7.2 Linear sorption isotherm with distribution coefficient (k_d) determined by linear regression.

interaction and aqueous phase contaminant concentrations are less than approximately 50% of their aqueous solubility (typically the case in ground water systems), a linear isotherm is generally observed (Karickhoff, 1981; Karickhoff, 1984; Karickhoff, et al., 1979). For the remainder of this section, only linear isotherm behavior will be considered.

If the k_d is known for a specific compound with a solid material of interest, the calculation of contaminant distribution is simple. For example, if the k_d value for benzene is 5 kg/L with a specific soil sample, and the ground water contains benzene at concentration is 1 mg/L, the sorbed benzene concentration would be 5 mg/kg. Beyond the evaluation of contaminant concentrations in both phases, the k_d allows for the determination of the fraction of the contaminant in the dissolved phase within a specific volume of an aquifer. This is an important consideration for calculating contaminant migration rates since only the dissolved fraction is subject to transport processes (Roberts, et al., 1986). The fraction of contaminant mass (f_w) present in the dissolved phase is defined mathematically in Eq. (7.3).

$$f_w = \frac{[A]_w V_w}{[A]_w V_w + [A]_s V_s} \quad (7.3)$$

$[A]_w$ and $[A]_s$ represent the concentration of contaminant in either the water or the solid, and V_w and V_s equal the volume of water and solid material being considered. If

$$[A]_s = k_d[A]_w \quad (7.4)$$

then

$$f_w = \frac{[A]_w V_w}{[A]_w V_w + k_d [A]_w V_s} = \frac{V_w}{V_w + k_d V_s} \quad (7.5)$$

Equation (7.5) can be simplified further if the porosity n , as defined in Eq. (7.6), of the aquifer is known.

$$n = \frac{V_w}{V_w + V_s} \quad (7.6)$$

As is shown in Eq. (7.7), f_w can be described simply a function of k_d and n .

$$f_w = \frac{1}{1 + \left(\frac{1}{n} - 1\right) k_d} \quad (7.7)$$

7.2.3 Predicting the Partition Coefficient, k_d

As stated previously, the sorption of nonionic organic molecules with aquifer materials is primarily due to an interaction with solid-phase natural organic matter. The extent to which this occurs is a function of two parameters: the amount of solid-phase natural organic matter present and the relative hydrophobicity of the contaminant itself. The amount of natural organic matter present is a site-specific parameter that cannot be estimated *a priori*. For example, some sands are almost devoid of organic material, while peat is almost exclusively organic in nature. Thus, the amount of solid-associated organic matter present in a given aquifer is determined in laboratory tests and is reported as the **fraction of organic carbon** (f_{oc}), a unitless term that describes the weight fraction of organic matter of the aquifer material. While the f_{oc} must be measured, it is possible to accurately estimate the relative hydrophobicity of a chemical using k_{ow} values. An increasing k_{ow} reflects an increasing degree of hydrophobicity and an increasing tendency to associate with natural organic matter. These properties that influence the partitioning of nonpolar organics can be incorporated in the mathematical description of k_d as is shown in Eq. (7.8) where k_{oc} is the partition coefficient between the contaminant and natural organic matter.

$$k_d = f_{oc} k_{oc} \quad (7.8)$$

Studies have demonstrated that k_{oc} is a predictable value based upon correlations between observed behavior and k_{ow} values. Table 7.2 presents these correlations for a range of chemicals.

Example 7.1. CALCULATION OF k_{oc}

Given the following results from an isotherm test, and assuming a f_{oc} of 0.02, calculate the k_{oc} value of the contaminant.

Aqueous Phase Concentration (mg/L)	Solid Phase Concentration (mg/kg)
0.1	0.8
0.2	1.6
0.3	2.4
0.4	3.2
0.5	4

Solution. Linear regression of the data yields k_d of 8 kg/L.

$$k_{oc} = k_d/f_{oc} = 400 \text{ kg/L}$$

Example 7.2 CALCULATION OF SORPTION EXTENT

Given a k_d of 8 kg/L and $n = 0.25$, calculate the fraction of contamination associated with the aquifer solids.

Solution.

$$f_s = (1 - f_w) = 1 - \frac{1}{1 + \left(\frac{1}{n} - 1\right)k_d}$$

$$f_s = 1 - \frac{1}{25} = 0.96$$

7.2.4 Sorption And Migration Retardation

To this point, we have focused on contaminant sorption without consideration of contaminant desorption. In the next section, desorption processes will be discussed in some detail. For now, let us assume that the sorption-desorption process can be described through a rapid equilibrium. Under these conditions, a contaminant molecule will associate and dissociate

TABLE 7.2 Regression Equations for the Estimation of k_{oc}

Equation (a)	No. (b)	r^2 (c)	Chemical Class Represented	Ref.
$\log k_{oc} = -0.55 \log S + 3.64$ (S in mg/L)	106	0.71	Wide variety, mostly pesticides	Kenaga et al., (1978)
$\log k_{oc} = -0.54 \log S + 0.44$ (S in mole fraction)	10	0.94	Mostly aromatic or polynuclear aromatics; two chlorinated	Karickhoff et al., (1979)
$\log k_{oc} = -0.557 \log S + 4.277$ (S in μ moles/L)	15	0.99	Chlorinated hydrocarbons	Chiou et al., (1979)
$\log k_{oc} = 0.544 \log k_{ow} + 1.377$	45	0.74	Wide variety, mostly pesticides	Kenaga et al. (1978)
$\log k_{oc} = 0.937 \log k_{ow} - 0.006$	19	0.95	Aromatics, polynuclear aromatics, triazines and dinitroaniline herbicides	Brown et al. (1981)
$\log k_{oc} = 1.00 \log k_{ow} - 0.21$	10	1.00	Mostly aromatic or polynuclear aromatics; two chlorinated	Karickhoff et al., (1979)
$\log k_{oc} = 0.94 \log k_{ow} + 0.02$	9	(e)	s-Triazines and dinitroaniline herbicides	Brown et al. (1981)
$\log k_{oc} = 1.029 \log k_{ow} - 0.18$	13	0.91	Variety of insecticides, herbicides and fungicides	Rao et al., (1980)
$\log k_{oc} = 0.524 \log k_{ow} + 0.855$	30	0.84	Substituted phenylureas and alkyl-N-phenylcarbamates	Briggs (1973)
$\log k_{oc} = 0.0067 (P-45N) + 0.237$	29	0.69	Aromatic compounds: ureas, 1,3,5-triazines, carbamates and uracils	Hance (1969)
$\log k_{oc} = 0.681 \log BCF + 1.963$ (f)	13	0.76	Wide variety, mostly pesticides	Kenaga et al., (1978)
$\log k_{oc} = 0.681 \log BCF + 1.886$ (f)	22	0.83	Wide variety, mostly pesticides	Kenaga et al., (1978)

- (a) k_{oc} = organic carbon sorption coefficient; S = water solubility; k_{ow} = octanol-water partition coefficient;
 (b) No. = number of chemicals used to obtain regression equation.
 (c) r^2 = correlation coefficient for regression equation
 (d) Equation originally given in terms of k_{om} . The relationship $k_{om} = k_{oc}/1.724$ was used to rewrite the equation in terms of k_{oc} .
 (e) Not available.
 (f) Specific chemicals used to obtain regression equation not specified.

from the solid phase with the net distribution of molecules being described by k_d . At times when a contaminant molecule is in the aqueous phase, it will move with the bulk flow of ground water. When the molecule is sorbed, it will be stationary. The net effect of this behavior is the **retardation** of contaminant transport relative to the rate of nonsorbing species (Domenico and Schwartz, 1998; Fetter, 1999).

Equation (7.9) is the 1-D advection-dispersion equation including contaminant sorption presented previously in Chapter 6 (Eq. (6.20)).

$$D_x \frac{\partial^2 C}{\partial x^2} - v_x \frac{\partial C}{\partial x} - \frac{\rho_b}{n} \frac{dS}{dt} = \frac{\partial C}{\partial t} \quad (7.9)$$

In this equation, C is the aqueous phase contaminant concentration, D_x is the dispersion coefficient, v_x is the ground water flow velocity, ρ_b is the bulk mass density (dry mass per volume soil), n is porosity, and S is the sorbed phase contaminant concentration (typically mg/kg). In cases where contaminant partitioning can be described with a linear isotherm, Eq. (7.9) can be rearranged to:

$$R \frac{\partial C}{\partial t} = D_x \frac{\partial^2 C}{\partial x^2} - v_x \frac{\partial C}{\partial x} \quad (7.10)$$

where R is the retardation factor defined in Eq. (7.11).

$$R = \left(1 + \frac{\rho_b}{n} k_d \right) \quad (7.11)$$

Conceptually, the retardation factor is the ratio of the ground water flow velocity to contaminant migration velocity. If $R = 10$, the ground water is moving, on average, ten times faster than the organic contaminant plume. An example of observed contaminant retardation is shown in Figure 7.3.

7.2.5 Desorption

The ability of chemicals to completely desorb from a solid is an area of current study (Fu, et al., 1994; Kan, et al., 1994; Kan, et al., 1997; Pignatello and Xing, 1995). The interest in this process stems from observations that cannot be reconciled with k_d values that describe the sorption process — in particular, the observation of solid phase contaminant concentrations exceeding the predicted concentration based on the aqueous phase contaminant concentration and k_d . Generally, this phenomena is observed in materials that have been contaminated for long time periods and contain low solid-phase contaminant concentrations (nominally less than 20 mg/kg). At high contaminant concentration, desorption patterns are generally predictable through equilibrium analysis. The importance of this observation is potentially enormous. Site remediation requirements include the removal of sorbed contamination.

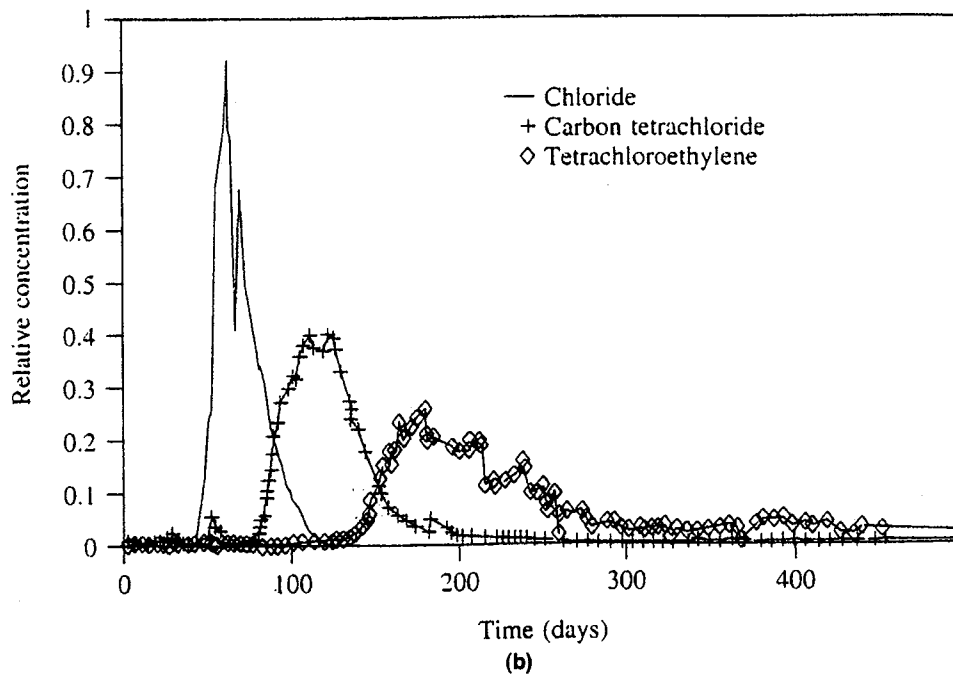
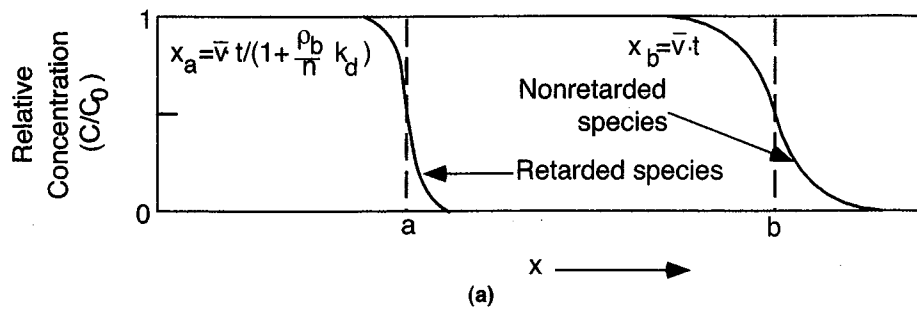

Figure 7.3 (a) Predicted advance of solutes in a one dimensional transport evaluation. (b) Observed field retardation data from the Borden landfill site, 5 meters downgradient from the injection well. Chloride is a non-sorbing tracer. Carbon tetrachloride and tetrachloroethylene are retarded by sorption.

If a contaminant does not desorb as readily as it sorbed, the ability to meet clean-up levels may be seriously threatened.

At this time, it is not possible to conclusively identify a physical mechanism that causes a resistance to desorption. One possible explanation is the rearrangement of the soil's natural organic matter as a result of contaminant sorption. After rearrangement, the contaminant can be physically sequestered within the organic matrix and not dissociate under condi-

tions predicted by equilibrium partitioning. This theory is analogous to enzyme-substrate binding where a macromolecule changes its 3-D structure in response to the association with a smaller molecule. Other possible mechanisms can describe the observation of desorption resistance, but are outside the scope of this book.

7.3 ABIOTIC FATE PROCESSES

Several chemical reaction mechanisms have been identified that impact the fate of certain organic chemical in ground water systems. These reactions do not include the direct involvement of living organisms and are thus referred to as **abiotic processes**. Types of abiotic reactions include hydrolysis, oxidation-reduction reactions, and elimination reactions (Schwartzbach, et al., 1993; Vogel and McCarty, 1987). The extent that any abiotic reactions may influence the fate of contaminants in the subsurface is highly compound-specific and can be strongly influenced by the conditions of the local environment. In this section, each process is discussed briefly.

7.3.1 Hydrolysis

Hydrolysis refers to a chemical reaction between a contaminant molecule and water. This process is important for certain contaminants, including alkyl halides, carboxylic acid esters, and carboxylic acid amides (Table 7.3). Common ground water contaminants such as aromatic hydrocarbons and chlorinated ethenes do not hydrolyze appreciably (Table 7.4). An example of a hydrolysis reaction is presented in Eq. (7.12) where 1-bromopropane reacts with water to form 1-propanol and bromide ion.

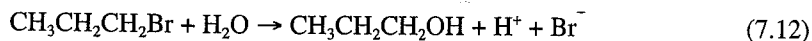

TABLE 7.3 Organic Functional Groups Generally Resistant to Hydrolysis

Alkanes	Aromatic amines
Alkenes	Alcohols
Alkynes	Phenols
Benzenes/biphenyls	Glycols
Polycyclic aromatic hydrocarbons	Ethers
Heterocyclic polycyclic aromatic hydrocarbons	Aldehydes
Halogenated aromatics/PCBs	Ketones
Dieldrin/aldrin and related halogenated hydrocarbon pesticides	Carboxylic acids
Aromatic nitro compounds	Sulfonic acids

Source : Lyman et al., 1990

TABLE 7.4 Types of Organic Functional Groups That Are Potentially Susceptible to Hydrolysis

Alkyl halides	Nitriles
Amides	Phosphonic acid esters
Amines	Phosphoric acid esters
Carbamates	Sulfonic acid esters
Carboxylic acid esters	Sulfuric acid esters
Epoxides	

Source : Lyman et al., 1990

The rate that a chemical undergoes hydrolysis is strongly influenced by the temperature and pH of the system (Schwartzbach, et al., 1993). As temperature increases, hydrolysis rates increase. As pH become either acidic or alkaline (e.g., greater than or less than 7.0) rates of acid-catalyzed or base-catalyzed hydrolysis can increase. Typically, hydrolysis is described with a first-order rate expression as shown in Eq. (7.13)

$$\frac{dC}{dt} = -k_{hyd}C \quad (7.13)$$

where C is the concentration of the chemical species and k_{hyd} is a first order hydrolysis rate coefficient. Knowing factors such as pH and temperature is important in determining the appropriate rate coefficient for a particular contaminant.

Example 7.3 HYDROLYSIS RATE CALCULATION

Calculate the time required for 95% of a chemical to hydrolyze in water assuming a hydrolysis rate coefficient of 0.001 day^{-1} .

Solution. To determine the time required, the rate expression must be integrated, yielding the following first-order rate expression

$$\ln \frac{C}{C_0} = -kt$$

so

$$\ln(0.05/1) = -0.001(t)$$

$$t_{0.05} = 2,995 \text{ days} = 8.2 \text{ years}$$

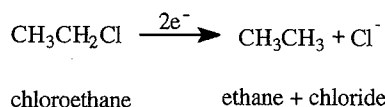
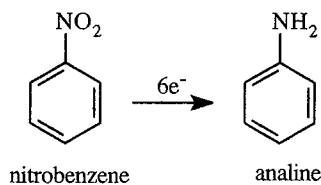

Figure 7.4 Examples of abiotic nitro reduction and abiotic dehalogenation reactions.

7.3.2 Oxidation-Reduction

Oxidation-reduction reactions involve the transfer electrons between a contaminant molecule and another chemical species. If the contaminant loses an electron, or electrons, it has been oxidized. If the contaminant gains electrons, it has been reduced. Inorganic compounds, such as reduced metals and reduced sulfur, are possible mediators of oxidation-reduction reactions (Klecka and Gonsior, 1984; Macalaldy, et al., 1986; Schwartzenbach, et al., 1990). The presence or absence of inorganic species is often dependent on local conditions. For example, many anaerobic environments will contain elevated levels of Fe(II), H₂S/HS⁻, and other reduced species that are capable of donating electrons and reducing certain contaminants. Examples of contaminants known to undergo abiotic oxidation-reduction reactions include halogenated hydrocarbons and nitroaromatics. Examples of each are presented in Figure 7.4. Biologically mediated oxidation-reduction reactions are often more rapid than abiotic reactions for many contaminants of interest in ground water systems, and thus abiotic oxidation-reduction are often neglected in transport calculations. In cases where they become important, oxidation-reduction processes are generally introduced as a first order reaction with respect to contaminant concentration — analogous to hydrolysis.

7.3.3 Elimination

Elimination reactions occur with a specific group of ground water contaminants, in particular, halogenated ethanes and propanes. For these chemicals, elimination reactions are characterized by the release of a halogen group and a proton from adjacent carbon atoms with the subsequent formation of a carbon-carbon double bond. An example of this is shown in Eq. (7.14), where the product of 1,1,1-trichloroethane elimination is 1,1-dichloroethene (Vogel and McCarty, 1987).

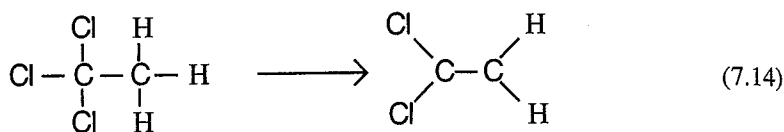

7.4 VOLATILIZATION

The transfer of a contaminant from the aqueous phase, nonaqueous phase liquid (NAPL), or sorbed phase directly to the gas phase is a process referred to as **volatilization**. The rate and extent to which volatilization occurs is strongly influenced by a number of parameters including the contaminant phase, the contaminant's vapor pressure, environmental factors (e.g., temperature, and others), proximity in respect to the vadose zone, and other site specific parameters (Mackay and Leinonen, 1975; Mackay and Wolkoff, 1973). Because of the range of factors that influence volatilization it becomes difficult to calculate the contribution of this process to the fate of chemicals in ground water.

In the simplest form, the process of volatilization can be illustrated in a manner analogous to the octanol-water partition test discussed previously. For the evaluation of volatilization however, consider a closed bottle that contains water and air instead of water and octanol. If a contaminant is introduced to the bottle (assuming that the resulting aqueous phase concentration does not exceed the aqueous solubility, thus avoiding the formation of a nonaqueous phase or a crystalline phase) and allowed to equilibrate, some fraction of the contaminant added will reside in the gas phase. The distribution of a chemical between the water and the gas at equilibrium is described by the **Henry's law coefficient** (Mackay, et al., 1979; Thibodeaux, 1996). Mathematically, Henry's law is presented in Eq. (7.15), where P_c is the partial pressure of the contaminant, $[C]_{aq}$ is the aqueous phase concentration of the contaminant, and H_c is the Henry's constant.

$$H_c = \frac{P_c}{[C]_{aq}} \quad (7.15)$$

Despite the relative simplicity of H_c , a factor that complicates the use of reported values of H_c is the variety of units used in its expression. The units of Eq. (7.15) are [L-atm/mol]. Henry's law coefficients are also commonly expressed in dimensionless form where the gas phase concentration is expressed as mole/L instead of partial pressures. Also, H_c is strongly influenced by temperature and the ionic strength of the aqueous solution.

In ground water systems that are isolated from the vadose zone, Henry's law can be applied to estimate the distribution of contaminants between the aqueous phase and the gas phase. If direct exchange is possible with the vadose zone, equilibrium may not be achieved and the calculation of gas phase concentrations is more difficult. In the latter case, the at-

(7.14)

mosphere acts as an infinite sink for the contaminant and gas phase concentrations are always less than equilibrium. Despite the lower gas concentrations observed, the net flux of contaminants to the gas phase under these conditions can be very significant. Additionally, volatilization from NAPL's in the vadose zone or floating on the water table can yield high concentrations of contaminants in the gas phase. A discussion of volatilization from NAPL's is presented in Chapter 11.

Example 7.4 USING HENRY'S CONSTANT

An aquifer contaminated with vinyl chloride contains a residual gas saturation of 10% (i.e., the percent of porosity containing gas). If the aqueous phase vinyl chloride concentration is 0.70 mg/L, calculate the gas phase concentration (mg/L) and the percent of total vinyl chloride mass in the gas phase of this two-phase system ($T = 25\text{ }^\circ\text{C}$, $P = 1\text{ atm}$).

$$H_c \text{ of vinyl chloride} = 22.4 \text{ L-atm/mol}$$

Step 1. Convert H_c to dimensionless form. At $25\text{ }^\circ\text{C}$ and 1 atm pressure, the partial pressure of vinyl chloride [atm] equals the moles of VC per total moles of gas. Using the ideal gas law, the volume of 1 mol gas under these conditions = 24.45 L, so

$$22.4 \frac{\text{L} \cdot \text{atm}}{\text{mol}} = 22.4 \frac{\text{L}_{\text{H}_2\text{O}} \cdot \text{mol}_{\text{VC}}}{\text{mol}_{\text{gas}} \cdot \text{mol}_{\text{H}_2\text{O}}} \times \frac{1 \text{ mol}_{\text{gas}}}{24.45 \text{ L}} = 0.916 \frac{\text{L}_{\text{H}_2\text{O}} \cdot \text{mol}_{\text{VC}}}{\text{L}_{\text{gas}} \cdot \text{mol}_{\text{H}_2\text{O}}}$$

Step 2. Calculate gas concentration

$$(0.7 \text{ mg/L}) (0.916) = 0.641 \text{ mg/L}$$

Step 3.

$$\begin{aligned} \text{Total mass} &= (0.7 \text{ mg/L})(0.9 \text{ L/L}) + (0.64 \text{ mg/L})(0.1 \text{ L/L}) \\ &= 0.69 \text{ mg/L Aquifer} \\ \text{mass in gas} &= 9\% \text{ of total} \end{aligned}$$

(7.15)

7.5 BIODEGRADATION

The **biodegradation** of contaminants refers to the complete conversion of a contaminant to mineralized end products (i.e., CO_2 , H_2O , and salts) through metabolism by living organisms. In ground water systems, the organisms that carry out this process are bacteria indigenous to the aquifer. In some cases, metabolic activity does change the chemical form of the

contaminant but does not result in the mineralization. In these cases, the term **biotransformation** is typically used to describe the processes occurring.

The metabolism of ground water contaminants is an extremely important fate process since it has the potential to impact the fate of all organic ground water contaminants, and is a process that has the potential to yield nonhazardous products. It is a complicated fate process due to the diversity of bacteria that may be involved, and range of metabolic processes that can be expressed (Young and Cerniglia, 1995). Before discussing specific aspects of contaminant metabolism by bacteria, a short discussion of important concepts regarding microbiology is presented to provide a foundation for further discussion.

7.5.1 Energy Flow and Metabolism

All living organisms require energy to survive and the capture of usable energy through the process of **catabolism** is a significant part of an organism's overall metabolism. There are two forms of energy that can support life – light energy and chemical energy. Certain bacteria are capable of using light as their energy source and are classified as **phototrophs**. Since light energy does not penetrate the earth's surface, the role of phototrophs in ground water systems is generally disregarded. Bacteria that obtain energy from chemical forms are classified as **chemotrophs**. Chemical energy sources are further differentiated as either inorganic or organic compounds. An organism that uses inorganic sources of energy is called a **lithotroph**. Examples of lithotrophic-substrates include ammonia (NH_3), hydrogen (H_2), ferrous iron (Fe^{2+}), and sulfide (HS^-). Organisms that use organic compounds as their energy source are called **organotrophs**. A comprehensive list of organotrophic-substrates would be enormous (just think of all the different foods you eat!). Examples of common ground water contaminants that serve as organotrophic-substrates include fuel components, PAH's, phenolics. Certain nitroaromatics and chlorinated solvents may also serve as a bacterium's energy source.

The extraction of energy from organic chemicals during catabolism occurs as a result of oxidation processes. As a chemical is oxidized, it loses electrons. For this reason, chemotrophic substrates are often referred to as **primary electron donors**. Electrons lost during oxidation are coupled with the reduction of electron acceptors. Eventually, the complex sequence of oxidation-reduction reactions that occur during catabolism results in the reduction of a **terminal electron acceptor**. Common terminal electron acceptors in ground water systems include oxygen (O_2), nitrate NO_3^- , ferric iron (Fe^{3+}), sulfate (SO_4^{2-}), and carbon dioxide (CO_2). When oxygen is the terminal electron acceptor, catabolism is classified **aerobic**. All other terminal electron acceptor conditions are classified as **anaerobic**. In most cases, an individual bacterial strain is capable of using only one terminal electron acceptor. The most common exceptions to this rule are **facultative aerobes** that can use nitrate as a terminal electron acceptor in the absence of oxygen. An important evaluation of contaminant biodegradation potential involves an analysis of the availability of primary electron donors and terminal electron acceptors, as their presence is required for organisms to obtain energy for survival and selects for the types of organisms that will be present.

The metabolism of organic contaminants can be broadly differentiated by the ability of organisms to use the contaminant for catabolic processes. If the compound is a primary electron donor and provides the bacterium with energy for cell growth, the contaminant is referred to as a **primary substrate**. In some cases, the oxidation of a contaminant will provide the cell with energy, but it is present at concentrations that are not sufficient to support the energy requirements of the organism. Contaminants of this type are referred to as **secondary substrates**. If a compound is metabolized fortuitously as the cell is obtaining energy from another primary electron donor, the transformation is referred to as **cometabolic**. The last category used to classify contaminant metabolism pertains to several very important contaminants and is referred to as **dehalorespiration**. In this case, certain chlorinated organics serve as an anaerobic terminal electron acceptor.

Bacterial Growth. Bacteria grow through the process of binary fission. In this process, a single cell divides into two cells that are identical to the original cell. The rate that bacteria grow is influenced by a number of parameters. For example, different strains have different minimum doubling times under ideal condition, and the observed rate of growth is controlled by substrate availability, temperature, and other environmental conditions. The classic demonstration of how a bacterial population responds to conditions that favor growth is shown in Figure 7.5. Initially, a lag phase is observed where growth does not occur. During this period, the organisms are adapting to the new medium conditions. Following the lag phase, microbial growth is exponential due to rapid binary fission of the microbes. Eventually, the culture enters stationary phase where bacterial numbers become constant. The cause of stationary phase is the depletion of an essential growth requirement in the medium. The availability of the **limiting substrate** then controls the ability of the culture to continue

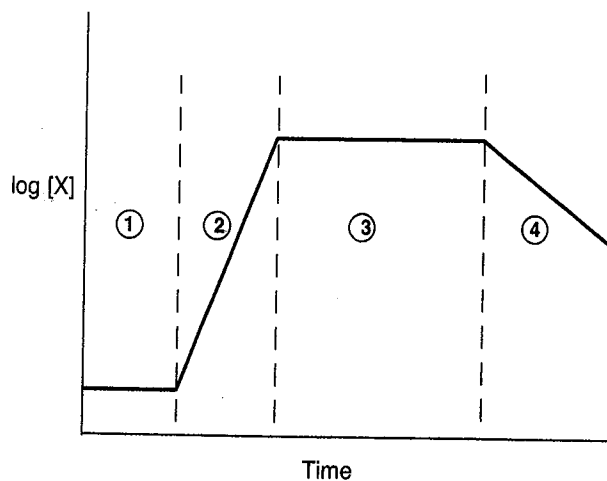

Figure 7.5 Microbial growth curve, where region 1 is the lag phase, region 2 is the exponential growth phase, region 3 is the stationary phase and region 4 is the decay phase.

to grow. Eventually, the medium becomes exhausted of constituents required to support viable organisms, and the culture enters the decay phase where cell death rates exceed any regrowth.

7.5.2 Stationary Phase Kinetics

A common interest in the evaluation of contaminant fate in the subsurface is the rate that contaminants are attenuated through biodegradation or biotransformation. Contaminant attenuation is typically evaluated with the assumption that organisms are in the stationary phase of growth, since lag phases and exponential growth occur rapidly relative to the time periods of interest in ground water systems. With this assumption, the rate of limiting substrate utilization can be predicted by the Monod expression (i.e., saturation kinetics) presented in Eq (7.16).

$$-\frac{dS}{dt} = \frac{kSX}{K_s + S} \quad (7.16)$$

In this equation, S is the limiting substrate concentration [mg/L], X is the biomass concentration [mass per volume or number per volume], k is the maximum substrate utilization rate [$S \cdot (X \cdot \text{time})^{-1}$], and K_s is the half-saturation coefficient [mg/L]. The behavior of this function is illustrated in Figure 7.6 where at low concentration it displays first-order behavior (rate is linearly proportional to S) and at high concentrations it approaches zero-order behavior (rate is independent of S). In many cases, the concentrations of limiting substrates in ground water are low and first-order kinetics are observed. This is true when $S \ll K_s$, in Eq. (7.16), which then reduces to Eq. (7.17):

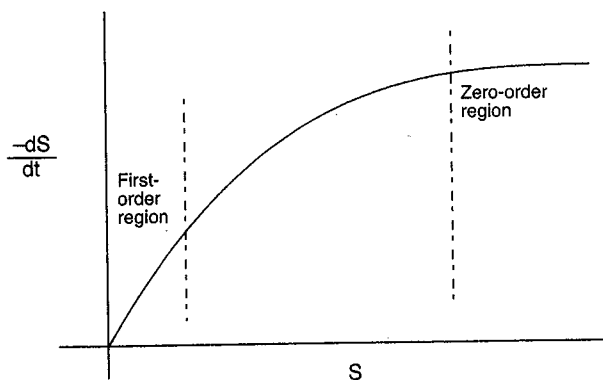
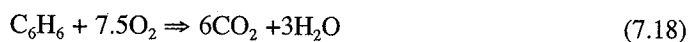

Figure 7.6 Observed rate of limiting substrate utilization (dS/dt) in a stationary phase bacterial culture. At low concentrations of S , $-dS/dt$ is directly proportional to ΔS . At high concentrations of S , $-dS/dt$ is unaffected by ΔS and the reaction rate is "saturated."

$$-\frac{dS}{dt} = \left(\frac{kX}{K_s}\right)S = k'S \quad (7.17)$$

In this case, k' is an apparent first-order rate coefficient (time^{-1}).

Based upon the rate of limiting substrate utilization, it is possible to use reaction stoichiometry to determine the rate that microorganisms utilize other constituents of interest (Lee, et al., 1988). This is particularly important when the contaminant itself is not the limiting substrate — a condition that is often the case in ground water systems. For example, consider the oxidation of benzene by aerobic bacteria. The solubility of benzene in water is approximately 1,800 mg/L (at 25°C), while the solubility of O_2 in water in contact with the atmosphere is roughly 9.0 mg/L. Based on the reaction stoichiometry written in Eq. (7.18), the consumption of 1 mg/L of benzene (C_6H_6) requires 3.1 mg/L of O_2 . Thus benzene concentrations of less than 3 mg/L can result in the complete utilization of dissolved oxygen in ground water. For this reason, it is common for the availability of O_2 to limit the extent of aerobic benzene oxidation (and the aerobic oxidation of other pollutants) and the rate of benzene attenuation will be predicted by the rate of O_2 utilization.



7.5.3 Dissolved Oxygen Impacts

For several reasons, the presence or absence of dissolved oxygen from ground water is an important component in the evaluation of aquifer microbiology. The first reason is the impact that dissolved oxygen has on the types of viable organisms present. Similar to human beings and other organisms, certain bacteria require oxygen to survive. If oxygen is not present, these organisms will die or become inactive. Interestingly, the inverse is true for anaerobic bacteria (Brock and Madigan, 1991). For these organisms, oxygen is acutely toxic. Thus the presence or absence of oxygen is a strong selective pressure for the types of organisms that will be active within any contaminant plume.

An additional role of dissolved oxygen in contaminant fate is its direct participation in certain oxidation reactions catalyzed by aerobic bacteria. In particular, reactions catalyzed by oxygenase enzymes. An example of an oxygenase enzyme catalyzed reaction is illustrated in Figure 7.7 where benzene is oxidized to catechol through the direct incorporation of O_2 into the contaminant molecule. Without O_2 , the reaction would not proceed. In addition to benzene, many other common contaminants are subject to oxygenase attack, including: fuel constituents, PAH's, certain chlorinated solvents, and others. This function of O_2 is physiologically distinct from its role as a terminal electron acceptor where oxygen is reduced forming water.

Example 7.5 STOICHIOMETRY OF CONTAMINANT METABOLISM

Assuming the following reaction, how much H₂ is required to reduce 1 mg/L PCE to ethene via reductive dechlorination?

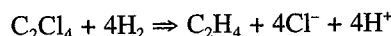

Based on the above stoichiometry, one mole of PCE (M.W. = 165.8) requires 4 moles of H₂ (M.W. = 2).

$$\frac{1 \text{ mg}_{\text{PCE}}}{\text{L}} \frac{1 \text{ mmol}_{\text{PCE}}}{165.8 \text{ mg}_{\text{PCE}}} \frac{4 \text{ mmol}_{\text{H}_2}}{1 \text{ mmol}_{\text{PCE}}} \frac{2 \text{ mg}_{\text{H}_2}}{1 \text{ mmol}_{\text{H}_2}} = \frac{0.0483 \text{ mg}_{\text{H}_2}}{\text{L}}$$

Therefore, 0.0483 mg/L of H₂ would be sufficient for the complete dechlorination of 1 mg/L PCE.

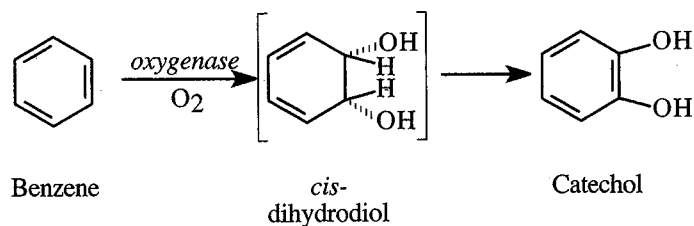

Figure 7.7 Enzymatic oxidation of benzene to catechol. The first step of benzene metabolism under aerobic conditions.

7.5.4 Metabolic Pathways Of Common Contaminants

An overview of how bacteria are capable of metabolizing various contaminants is presented in the following sections. It is important to note that this continues to be an area of intense research. Paradigms continue to change and it is difficult to assert definitive analysis regarding the totality of metabolic processes that may impact an individual contaminant's fate. To this end, the following sections focus on established concepts but also illustrate current uncertainties.

Monoaromatic Hydrocarbons. As constituents of gasoline, diesel, and jet fuels, monoaromatic hydrocarbons are common ground water contaminants due to accidental spills and leaking underground storage tanks. Of particular concern are benzene, toluene, ethylbenzene and xylene isomers – collectively abbreviated as BTEX. Under aerobic conditions, all BTEX compounds are rapidly biodegraded as primary substrates (Alvarez and Vogel, 1991). Unfortunately, the oxygen demand resulting from the aerobic oxidation of these compounds

can exceed the solubility of oxygen in water. Dissolved oxygen concentrations are rapidly depleted due to the biodegradation of these and other fuel constituents, yielding anaerobic conditions in contaminated aquifers (Lee, et al., 1988).

The biodegradation of BTEX compounds under anaerobic conditions is not as well characterized as it is under aerobic conditions. Only recently has the biodegradation of all BTEX compounds been confirmed under all anaerobic electron acceptor conditions in laboratory studies. From these studies it appears that toluene is the most degradable under all electron acceptor conditions and benzene is the least degradable. In many laboratory studies conducted under anaerobic conditions, benzene degradation is not observed. Certain modeling studies of certain well-characterized contaminated field sites infer that anaerobic benzene degradation may occur *in situ*. Several recent laboratory studies conducted under anaerobic conditions have demonstrated that benzene may degrade in the absence of oxygen (Lovely, et al. 1995). Certainly the anaerobic biodegradation of BTEX is possible, and the anaerobic degradation of TEX most likely occurs in many contaminated sites. The factors controlling the rate or extent of anaerobic benzene biodegradation have not been elucidated, making an *a priori* evaluation of this potentially important fate pathway difficult at this time. In any case, the anaerobic degradation of BTEX compounds is generally slower than observed through aerobic processes.

Polynuclear Aromatic Hydrocarbons. The class of contaminants referred to as polynuclear aromatic hydrocarbons (PAHs) represent a number of compounds with physicochemical characteristics that vary dramatically. In particular, the aqueous phase solubility (i.e., hydrophobicity) varies from approximately 30 mg/L for naphthalene to less than 1 μ g/L for benzo(a)-pyrene. PAHs sorb extensively due to their high hydrophobicity, resulting in low observed aqueous phase concentrations of these contaminants. PAH biodegradation is generally limited to aerobic metabolism that is initiated by oxygenase attack (similar to that depicted in Figure 7.7). PAHs of three or fewer rings, including naphthalene, fluorene, and phenanthrene are known to be primary substrates for bacterial growth. Larger and more hydrophobic PAHs (i.e., four rings and higher) tend to behave as secondary substrates in the presence of the smaller, more water soluble PAHs (Hughes, et al., 1997). The observation of anaerobic PAH metabolism is rare, and is limited to naphthalene.

Phenolic Compounds. Phenol and chlorinated phenols are biodegraded as primary substrates under aerobic and anaerobic conditions. These compounds are often recalcitrant in the environment due to their toxicity and the low water solubility of certain chlorinated forms (i.e., pentachlorophenol (PCP)). When present at concentrations below toxic thresholds, phenols can be rapidly mineralized by a wide range of microorganisms. As the number of chlorine substituents increases, the rate of degradation often decreases.

MTBE. Fuel additives (also called oxygenates) have been in use in the United States for approximately two decades. These compounds have been added to gasoline to increase octane ratings and to decrease exhaust emissions of certain air pollutants. Since the late 1980's, the most common additive used for either purpose has been **methyl tert-butyl ether (MTBE)**. The percent of gasoline comprised by MTBE is as high as 10% in regions of the country where urban air pollution exceeds federal standards, and MTBE is now a common contaminant of ground water as a result of gasoline spills. Since MTBE is currently

listed as a probable human carcinogen, its presence in ground water is of concern. Furthermore, MTBE is more soluble, less volatile, and less hydrophobic than other fuel constituents (i.e., BTEX compounds). Thus, it is prone to dissolve to higher aqueous phase concentrations than other fuel-derived contaminants and migrate more rapidly (Squillace et al., 1997.).

Since MTBE has only recently become a ground water concern, less is known regarding its biodegradability than many other pollutants. Based on its chemical structure, MTBE is not a compound that would be expected to be readily biodegradable. MTBE contains two structural features that generally reduce biodegradability. The first is the highly stable ether linkage between the methyl- and *tert*-butyl group. Second is the degree of branching associated with the *tert*-butyl group itself. There are several studies that suggest that MTBE can be biodegraded under conditions representative of the subsurface; however, degradation is not always observed in controlled laboratory tests and observations from contaminated sites often indicate limited, if any, biodegradation (Borden et al., 1997; Schirmer and Barker, 1998).

Based on current information, MTBE biodegradation is more likely to occur under aerobic conditions than anaerobic conditions. Aerobic oxidation of MTBE may occur via cometabolic degradation (Steffan et al., 1997) and as a growth substrate (Mo et al., 1997; Salanitro et al., 1994.). In aerobic conditions, oxidation of MTBE is initiated at the ether link and *tert*-butyl alcohol is often observed as an intermediate (depicted in Eq. 7.19). Further oxidation can result in CO₂ formation (Bradley et al., 1999). Under anaerobic conditions, degradation has rarely been observed (Mormile et al., 1994; Yeh and Novak, 1994; Squillace et al. 1997). In cases where anaerobic degradation has been documented, pathways similar to those observed under aerobic conditions are believed to occur.

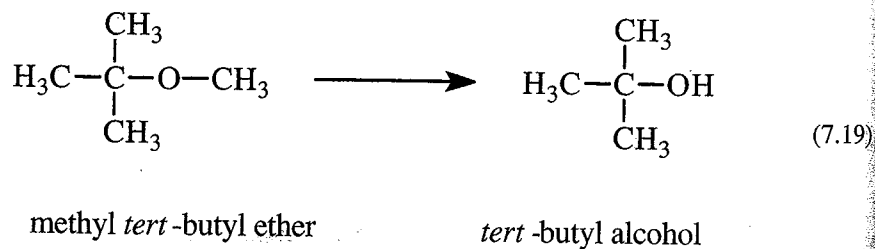

The extent to which anaerobic or aerobic biodegradation processes will influence the fate of MTBE in contaminated aquifers is the basis for current research and experimentation. Certainly, our understanding of its biodegradation is far behind what is known regarding other common contaminants. Based on the information available, MTBE appears to be a highly mobile and highly recalcitrant ground water pollutant.

Chlorinated Solvents. Chlorinated methanes, ethanes, and ethenes comprise a group of compounds commonly referred to as chlorinated solvents. These compounds have been used extensively as degreasers, dry cleaning agents, and paint removers, and their presence and persistence in the environment is widespread (Pankow and Cherry, 1996). Chlorinated solvents used extensively in the United States (also see Chapter 4) include: per-

chloroethene (PCE), trichloroethylene (TCE), 1,1,1-trichloroethene (TCA), carbon tetrachloride, and dichloromethane (e.g., methylene chloride).

The metabolism of chlorinated solvents is perhaps more diverse than any other group of environmental contaminants. Depending on the compound of interest, the electron acceptor condition, and the presence of inducing substrates, the metabolism of chlorinated solvents may occur through primary metabolism, secondary metabolism, cometabolism, or through terminal electron acceptor processes. Additionally, the metabolism of these compounds often does not result in the formation of benign products. This is particularly true for metabolism through cometabolic processes or through terminal electron accepting processes.

Only a few chlorinated solvents are known to be primary substrates for growth. Dichloromethane is a primary substrate under both aerobic and anaerobic conditions and is perhaps the most biodegradable of all the chlorinated solvents (Brunner, et al., 1980; Freedman and Gossett, 1991). Vinyl chloride, a compound used to produce PVC materials and a biotransformation product of PCE and TCE, can be used as an electron donor under aerobic conditions. Isomers of DCE may also be oxidized under aerobic conditions as growth substrates. This process is not well understood, however, and often is not observed at contaminated sites. The secondary metabolism of chlorinated solvents may occur when contaminants are present at low concentration, but is limited to those compounds that can serve as primary substrates.

A common anaerobic biotransformation process for chlorinated solvents is **reductive dechlorination**. A half-reaction that describes this process is shown in Eq. (7.20).

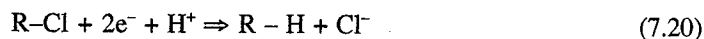

In this example, R (a generic notation for any organic compound) is being reduced with the evolution of chloride ion. The reducing equivalents (e^-) for this process originate from the oxidation of a primary electron donor. The process of reductive dechlorination results in the formation a number of chlorinated and non-chlorinated compounds (Bouwer and McCarty, 1983). This is illustrated in Figures 7.8 through 7.10 for common chlorinated methanes, ethanes and ethenes.

The process of reductive dechlorination may result from either cometabolic processes or dehalorespiration. At this time, dehalorespiration has been confirmed for the chlorinated ethene series only (cometabolism of chlorinated ethenes is also possible). In general, cometabolic transformations are slow and the reducing equivalents consumed account for only a small percent of the electron donor consumed. Various anaerobes are capable of cometabolic reductive dechlorination, including methanogens. This is due to the nonspecific nature of the reaction. Reduced cofactors that are present in many anaerobes, including vitamin B-12, are responsible for catalyzing cometabolic reductive dehalogenation (Egli, et al., 1990, Gantzer and Wackett, 1991, Wood, et al., 1968).

Dehalorespiration is a rapid reaction in comparison to cometabolic transformation, and it is possible for a high percent of the reducing equivalents generated through the oxidation

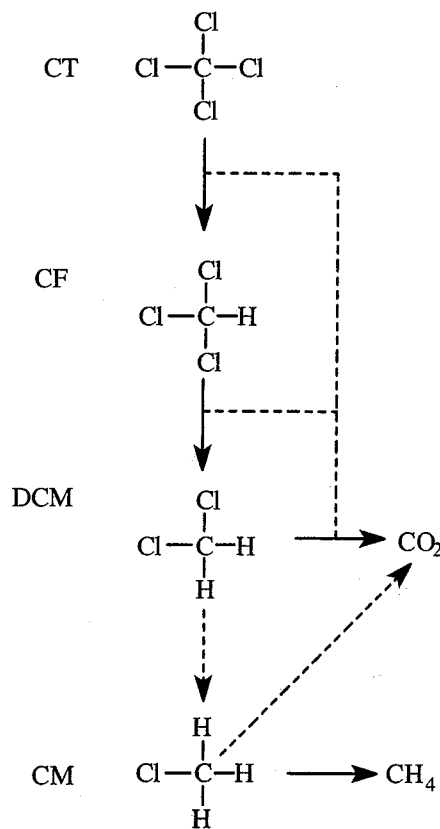

Figure 7.8 Pathway for the anaerobic metabolism of chlorinated methanes. Initial metabolism of carbon tetrachloride (CT) and chloroform (CF) metabolism are reduction to the level of dichloromethane (DCM). Subsequent metabolism results eventually in CO_2 production, although traces of chloromethane (CM) may accumulate as an intermediate. Source: Egli, et al., 1988; Freedman and Gossett, 1991; Galli and McCarty, 1989.

of electron donors to be used in this form of metabolism. To date, a handful of organisms capable of dehalorespiration have been isolated. Most are capable of dechlorinating PCE and TCE to the level of *cis*-DCE only. One isolate, *Dehalococcoides ethenogenes* strain 195, is known to carry out PCE dehalorespiration to the level of ethene (Maymó-Gatell, et al., 1997). At contaminated sites, high levels of vinyl chloride and ethene are often observed – indicating that this form of metabolism beyond DCE may be common. One important aspect of dehalogenation processes is the interaction of these organisms with other anaerobes, in particular, fermentative bacteria that produce hydrogen as a bi-product of organotrophic catabolism. Hydrogen is a preferred primary substrate for dechlorinators and thus these organ-

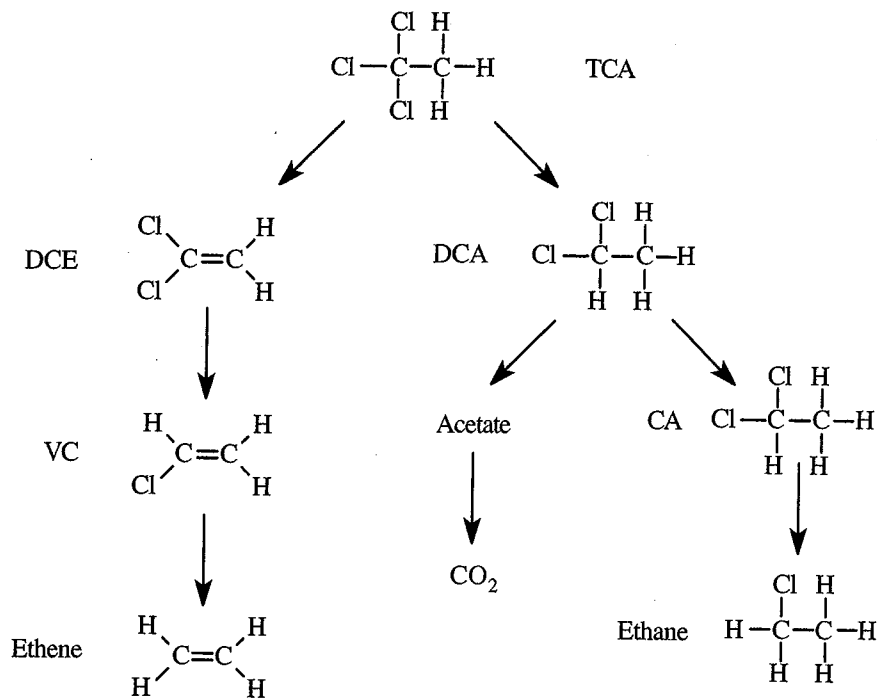

Figure 7.9 Pathway for the anaerobic transformation of a common chlorinated ethane 1,1,1-trichloroethane (TCA) through reductive dechlorination and dehydrodehalogenation. Reductive dechlorination yields dichloroethane (DCA) which can be oxidized to acetate or reduced to chloroethane (CA). Dehydrodehalogenation yields 1,1-dichloroethene (DCE), which can then be reduced to vinyl chloride (VC), and eventually ethene. Source: Galli and McCarty, 1989; Vogel, et al., 1987.

isms rely on the activity of the fermentors. Also, hydrogen production via fermentation is strongly influenced by the types of organic substrates present. It is important to note that lithotrophic organisms utilize hydrogen as well and compete with dehalorespiring bacteria for the "hydrogen pool" in anaerobic environments (Carr and Hughes, 1998; DiStefano, et al., 1991).

A distinct form of chlorinated solvent metabolism is oxidation through cometabolic processes. These reactions are the result of oxygenase activity expressed by organisms utilizing certain primary substrates – not chlorinated solvents – for catabolic purposes. Examples of substrates that induce oxygenase enzymes capable of chlorinated solvent cometabolism include monoaromatic hydrocarbons, methane (and other alkanes), and ammonia. This process has been studied in detail due to the potential for nonhazardous end-product formation (including CO_2) (Young and Cerniglia, 1995). Several interesting aspects of this metabolism

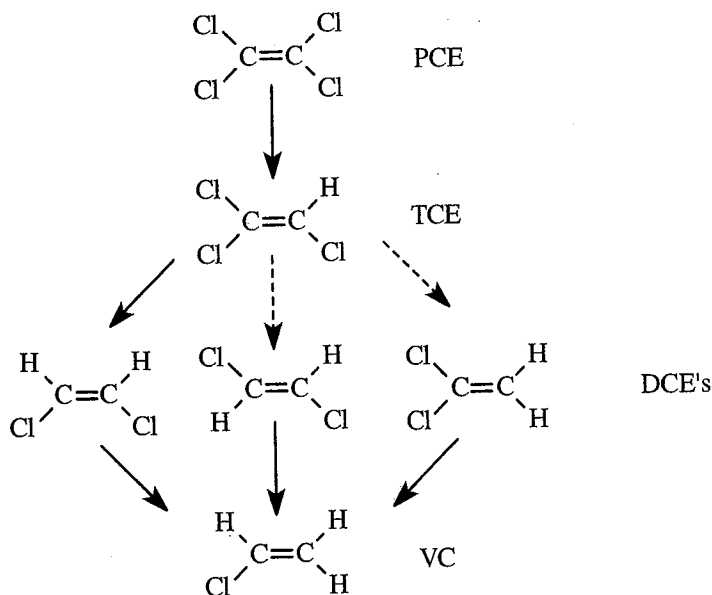

Figure 7.10 Reductive dechlorination of chlorinated ethenes including perchloroethene (PCE), trichloroethene (TCE), the three isomers of dichloroethene (DCE's), vinyl chloride (VC). Dechlorination of VC would yield a non-chlorinated product – ethene. Source: Belay and Daniels, 1987; Freedman and Gossett, 1989; Vogel and McCarty, 1985.

7.6 E

influence the rate and extent to which this process will occur. First, is the oxygenase enzyme itself. Oxygenases, induced by various substances, differ in their intrinsic rates of chlorinated solvent oxidation. Second, the inducing substance acts as a competitive inhibitor for chlorinated solvent binding, reducing reaction rates. Third, the reaction catalyzed by the oxygenase results in the formation of compounds that are toxic to the microorganism. For example, the product of TCE oxidation is TCE-epoxide, a highly reactive molecule that reacts rapidly with cell components. After cometabolizing a certain mass of chlorinated solvent, the cell loses viability due to product toxicity (Alvarez-Cohen and McCarty, 1991).

Not all chlorinated solvents are oxidized through cometabolism. PCE and carbon tetrachloride are resistant to this process, and TCA is poorly metabolized in this manner. TCE, DCE's, and vinyl chloride can be cometabolized. Chloroform (the dehalogenation product of carbon tetrachloride) is oxidized by oxygenase enzymes. This reaction is rarely sustained, however, as the product of oxidation is phosgene – a short-lived but highly toxic compound. Cometabolic degradation of chlorinated solvents has been studied primarily as an engineered bioremediation system, although it may be an important component of chlorinated solvent natural attenuation, in particular, at sites where chlorinated solvents are found in the presence

of inducing substances (e.g., fuel constituents or dissolved methane gas) and dissolved oxygen.

Nitroaromatic Compounds. Nitroaromatics are common pollutants of water and soils as a result of their use in plastics, dyes, and explosives. The nitro group is a strong electron withdrawing functionality that reduces the efficacy of oxygenase attack of the aromatic ring. Recent studies have demonstrated that certain organisms are capable of oxidizing certain nitroaromatic compounds and to obtain energy for growth (i.e., primary metabolism). This activity is generally limited to nitroaromatics containing two or fewer nitro groups (Reiger and Knackmuss, 1995).

Under anaerobic conditions, nitroaromatic transformation generally yields reduced aromatic products. For example, the product of the complete reduction of nitrobenzene is aniline (aminobenzene). The formation of an aryl amine from an aryl nitro group requires that two intermediate forms be produced. First is the aryl nitroso intermediate followed by an aryl hydroxylamine. Recent work has demonstrated the importance of the aryl hydroxylamine intermediate in the ultimate fate of nitroaromatics under anaerobic conditions. The hydroxylamine can be reduced to the amine, or undergo more complex reactions that can result in the binding with natural organic matter or the formation of an aminophenol through rearrangement reactions (Hughes, et al., 1998; Hughes, et al., 1999).

7.6 EVALUATION OF FATE PROCESSES

Translating molecular level fate process to field-scale evaluations is a difficult but important task. The heterogeneous nature of the subsurface is a significant complicating factor. For example, the organic carbon content of aquifer solids can vary enormously with depth as different geologic units are encountered. This variation must be considered in the prediction of contaminant retardation. Electron acceptor condition is another spatial variable that is extremely important to characterize for the accurate evaluation of contaminant fate as the rate biodegradation processes are strongly controlled by this factor. Several tools are available to assist in these evaluations and are briefly discussed in the remainder of this chapter.

7.6.1 Site Characterization

Specific measurements and other site information used to characterize contaminated aquifers discussed in Chapter 5 are used extensively in the assessment of fate processes at individual sites. For example, the distribution of contaminants and the existing ground water chemistry are typically obtained during site characterization. With this data, it is possible to identify areas where different forms of metabolism may be occurring (i.e., aerobic or anaerobic). Also, site characterization facilitates the evaluation of sorption and retardation, as f_{oc} distributions will typically be evaluated in contaminated areas. In some cases, additional information may be required beyond standard site characterization. This may include additional work at the contaminated site. Frequently, studies are conducted in the laboratory or through modeling.

studies to support the evaluation of fate processes. Each is discussed in the following two paragraphs.

7.6.2 Microcosm Studies

Microcosm studies are laboratory evaluations of fate processes specific to a contaminated area, where materials are obtained from contaminated areas and experiments can be conducted in a controlled setting. An example of a common microcosm study is the evaluation of contaminant biodegradation rates under site conditions. In these tests, samples of aquifer solids and ground water are obtained from contaminated areas of interest. The materials are taken to the lab and transferred into bottles, which can be sealed and incubated. Care is taken in the construction of microcosms not to change conditions and perturb the results. For example, if a site is anaerobic, the construction of the microcosm will be conducted in a manner to avoid the introduction of oxygen. Samples are taken periodically, and the rate of contaminant degradation can be calculated directly. The results of microcosm studies can be very beneficial in cases where unusual field conditions are encountered, or where additional confidence is required. They are not, however, a common component of site characterization.

7.6.3 Modeling

Contaminant transport models are very valuable tools that can be used to approximate the rate of extent of fate processes occurring at contaminated sites. Details regarding the use of fate and transport models are presented in Chapters 8, 10, and 12. Basically, modeling studies are used to incorporate the characteristics of a site's hydrogeology, contaminants, and ongoing fate processes to predict the observed distribution of contaminants and their concentrations. The calibration of models requires an understanding of the processes that are occurring, their rates, and the extent to which they are exerted spatially. Often, this process of model calibration will yield approximate transformation rates (abiotic and biotic), volatilization rates, or the retardation coefficient. Site modeling is particularly valuable because the calibration of these models to what has occurred to date allows for prediction of contaminant fate into the future.

SUMMARY

Sorption, abiotic transformation, volatilization, and biodegradation processes have a significant impact on the transport and fate of organic chemicals in ground water. Sorption retards transport through the accumulation of contaminants on the stationary solid phase and strongly influences the time required to remediate contaminated sites. Abiotic transformation processes are important for certain contaminant classes and may represent a significant removal process for those contaminants. Volatilization is a mechanism where contaminants may be lost from the water to the vadose zone. This is further discussed in Chapter 11. Bio-

degradation is a very important fate process since it can impact any organic chemical in ground water. The rate and extent of biodegradation is dependent on site-specific conditions. In some cases, biodegradation is not complete, yielding hazardous end products. Site characterization efforts or remediation plans must account for these processes in order to obtain accurate predictions of contaminant behavior in ground water systems.

REFERENCES

- Alvarez, P. J. J. and T. Vogel, "Substrate Interactions of Benzene, Toluene, and para-Xylene During Degradation by Pure Cultures and Mixed Culture Aquifer Slurries," *Appl. Environ. Microbiol.*, 57:2981-2985, 1991.
- Alvarez-Cohen, L. and P. L. McCarty, "Product Toxicity and Cometabolic Competitive Inhibition Modeling of Chloroform and Trichloroethylene Transformation by Methanogenic Resting Cells," *Appl. Environ. Microbiol.*, 57:1031-1037, 1991.
- Belay, N. and L. Daniels, "Production of Ethane, Ethylene, and Acetylene from Halogenated Hydrocarbons by Methanogenic Bacteria," *Appl. Environ. Microbiol.*, 53:1604-1610, 1987.
- Borden, Robert C., R. A. Daniel, L. E. LeBrun IV, and C. W. Davis, "Intrinsic Biodegradation of MTBE and BTEX in a Gasoline-Contaminated Aquifer," *Water Resources Res.*, vol. 33, No. 5, pp. 1105-1115, 1997.
- Bouwer, E. J. and P. L. McCarty, "Transformation of 1- and 2-Carbon Halogenated Aliphatic Organic Compounds Under Methanogenic Conditions," *Appl. Environ. Microbiol.*, 45:1286-1294, 1983.
- Bradley, Paul M., J. E. Landmeyer, and F. H. Chapelle, "Aerobic Mineralization of MTBE and tert-Butyl Alcohol by Stream-Bed Sediment Microorganisms," *Environ. Sci. Technol.*, 33, pp. 1877-1879, 1999.
- Briggs, G. G., "A Simple Relationship between Soil Adsorption of Organic Chemicals and Their Octanol/Water Partition Coefficients," *Proc. 7th British Insecticide and Fungicide Conf.*, Boots Company Ltd., G. B. Nottingham, Vol. 1, 1973.
- Brock, T. D. and M. T. Madigan, *Biology of Microorganisms*, Englewood Cliffs, NJ, Prentice Hall, 1991.
- Brunner, W., D. Staub, and T. Leisinger, "Bacterial Degradation of Dichloromethane," *Appl. Environ. Microbiol.*, 40:950-958, 1980.
- Brown, D. S., S. W. Karickhoff and E. W. Flagg, "Empirical Prediction of Organic Pollutant Sorption in Natural Sediments," *J. Environ. Qual.* (103):382-386, 1981.
- Carr, C. S. and J. B. Hughes, "Enrichment of High Rate PCE Dechlorination and Comparative Study of Lactate, Methanol, and Hydrogen as Electron Donors to Sustain Activity," *Environ. Sci. and Technol.*, 32:1817-1824, 1998.
- Chiou, C. T., L. J. Peters, and V. H. Freed, "A Physical Concept of Soil-water Equilibria for Non-ionic Organic Compounds," *Science*, 206:831-832, 1979.
- DiStefano, T. D., J. M. Gossett, and S. H. Zinder, "Reductive Dechlorination of High Concentrations of Tetrachloroethene to Ethene by an Anaerobic Enrichment Culture in the Absence of Methanogenesis," *Appl. Environ. Microbiol.*, 57:2287-2292, 1991.
- Domenico, P.A., and F. W. Schwartz, *Physical and Chemical Hydrogeology*, 2nd edition, New York, John S. Wiley and Sons, 1998.

studies to support the evaluation of fate processes. Each is discussed in the following two paragraphs.

7.6.2 Microcosm Studies

Microcosm studies are laboratory evaluations of fate processes specific to a contaminated area, where materials are obtained from contaminated areas and experiments can be conducted in a controlled setting. An example of a common microcosm study is the evaluation of contaminant biodegradation rates under site conditions. In these tests, samples of aquifer solids and ground water are obtained from contaminated areas of interest. The materials are taken to the lab and transferred into bottles, which can be sealed and incubated. Care is taken in the construction of microcosms not to change conditions and perturb the results. For example, if a site is anaerobic, the construction of the microcosm will be conducted in a manner to avoid the introduction of oxygen. Samples are taken periodically, and the rate of contaminant degradation can be calculated directly. The results of microcosm studies can be very beneficial in cases where unusual field conditions are encountered, or where additional confidence is required. They are not, however, a common component of site characterization.

7.6.3 Modeling

Contaminant transport models are very valuable tools that can be used to approximate the rate of extent of fate processes occurring at contaminated sites. Details regarding the use of fate and transport models are presented in Chapters 8, 10, and 12. Basically, modeling studies are used to incorporate the characteristics of a site's hydrogeology, contaminants, and ongoing fate processes to predict the observed distribution of contaminants and their concentrations. The calibration of models requires an understanding of the processes that are occurring, their rates, and the extent to which they are exerted spatially. Often, this process of model calibration will yield approximate transformation rates (abiotic and biotic), volatilization rates, or the retardation coefficient. Site modeling is particularly valuable because the calibration of these models to what has occurred to date allows for prediction of contaminant fate into the future.

SUMMARY

Sorption, abiotic transformation, volatilization, and biodegradation processes have a significant impact on the transport and fate of organic chemicals in ground water. Sorption retards transport through the accumulation of contaminants on the stationary solid phase and strongly influences the time required to remediate contaminated sites. Abiotic transformation processes are important for certain contaminant classes and may represent a significant removal process for those contaminants. Volatilization is a mechanism where contaminants may be lost from the water to the vadose zone. This is further discussed in Chapter 11. Bio-

REF

degr
grou
In sc
teriz
accu

REFERE

Alvai
in
bi
Alvai
M
C
Belay
dr
Borde
M
PP
Bouw
ga
12
Bradk
Bu
18
Briggs
Oc
Co
Brock
Ha
Brunn
vir
Brown
tion
Carr, C
Stu
Sci.
Chiou,
ioni
DiStef
tion
Met
Domen
Yor

- Egli, C., Stromeyer, S., Cook, A. M. and Leisinger, T., "Transformation of Tetra- and Trichloromethane to CO₂ by Anaerobic Bacteria is a Non-Enzymatic Process," *FEMS Microbiol. Let.*, 68:207-212, 1990.
- Egli, C., T. Tschan, R. Scholtz, A. M. Cook, and T. Leisinger, "Transformation of Tetrachloromethane to Dichloromethane and Carbon Dioxide by *Acetobacterium Woodii*," *Appl. Environ. Microbiol.*, 54:2819-2842, 1988.
- Fetter, C.W., *Contaminant Hydrogeology*, 2nd edition, New York, Prentice Hall, 1999.
- Freedman, D. L. and J. M. Gossett, "Biological Reductive Dechlorination of Tetrachloroethylene and Trichloroethylene to Ethylene Under Methanogenic Conditions," *Appl. Environ. Microbiol.*, 55:2144-2151, 1989.
- Freedman, D. L. and J. M. Gossett, "Biodegradation of Dichloromethane and its Utilization as a Growth Substrate Under Methanogenic Conditions," *Appl. Environ. Microbiol.*, 57:2847-2857, 1991.
- Fu, G., Kan, A.T., and M. B. Tomson, "Adsorption and Desorption irreversibility of Polycyclic Aromatic Hydrocarbons in Surface Sediment. I. Characterization of Desorption Hysteresis," *Environ. Toxicol. Chem.*, 13(10):1559-1567, 1994.
- Galli, R. and P. L. McCarty, "Biotransformation of 1,1,1-Trichloroethane, Trichloromethane, and Tetrachloromethane by a *Clostridium* sp.," *Appl. Environ. Microbiol.*, 55:837-844, 1989.
- Gantzer, C. J. and L. P. Wackett, "Reductive Dechlorination Catalyzed by Bacterial Transition-Metal Coenzymes," *Environ. Sci. Technol.*, 25:715-722, 1991.
- Hance, R.J., "An Empirical Relationship between Chemical Structure and the Sorption of Some Herbicides by Soils," *J. Agric. Food Chem.* 17:667-668, 1969.
- Hughes, J. B., C. Wang, and C. Zhang, "Anaerobic Transformation of 2,4- and 2,6-Dinitrotoluenes by *Clostridium acetobutylicum*: A Pathway Through Dihydroxylamino-Intermediates," *Environ. Sci. Technol.*, 1999.
- Hughes, J. B., C. Wang, K. Yesland, A. Richardson, R. Bhadra, G. Bennett, and F. Rudolph, "Bamberger Rearrangement During TNT-Metabolism by *Clostridium acetobutylicum*," *Environ. Sci. Technol.*, 32:494-500, 1998.
- Hughes, J. B., D. M. Beckles, S. D. Chandra, and C. H. Ward, "Utilization of Bioremediation Processes for the Treatment of PAH-Contaminated Sediments," *J. Indust. Microbiol. and Biotech.*, 18:152-160, 1997.
- Kan, A. T., G. Fu, and M. B. Tomson, "Adsorption/Desorption Hysteresis in Organic Pollutant and Soil/Sediment Interaction," *Environ. Sci. Technol.*, 28:859-867, 1994.
- Kan, A. T., G. Fu, M. A. Hunter, and M. B. Tomson, "Irreversible Adsorption of Naphthalene and Tetrachlorobiphenyl to Lula and Surrogate Sediments," *Environ. Sci. Technol.*, 31:2176-2185, 1997.
- Karickhoff, S.W., "Estimation of Sorption of Hydrophobic Semi Empirical Pollutants on Natural Sediments and Soils," *Chemosphere*, 108:833-846, 1981.
- Karickhoff, S.W., "Organic Pollutant Sorption in Aquatic Systems," *J. Hydraulic Engineering*, 110(6):707-735, 1984.
- Karickhoff, S. W., D. S. Brown, T. A. and Scott, "Sorption of Hydrophobic Pollutants on Natural Sediments," *Water Res.*, 13:241-248, 1979.
- Kenaga, E. E., and C. A. I. Goring, "Relationship Between Water Solubility, Soil-Sorption, Octanol-Water Partitioning, and Bioconcentration of Chemicals in Biota," prepublication copy of paper dated October 13, 1978, given at the American Society for Testing and Materials, Third Aquatic Toxicology Symposium, October 17-18, New Orleans, LA, 1978.

- Klecka, G. M. and S. L. Gonsior "Reductive Dechlorination of Chlorinated Methanes and Ethanes by Reduced Iron II) Porphyrins," *Chemosphere*, 13:391-402, 1978.
- Lee, M. D., J. M. Thomas, R. C. Borden, P. B. Bedient, C. H. Ward, and J. T. Wilson, "Bioremediation of Aquifers Contaminated with Organic Compounds," *CRC Crit. Rev. Environ. Control*, 18:29-89, 1988.
- Lovely D. R., J. D. Coates, J. C. Woodward and E. J. P. Phillips, "Benzene oxidation coupled to sulfate reduction," *Appl. Environ. Microbiol.*, 61:953-958, 1995.
- Lyman, W. J., W. F. Reehl, and D. H. Rosenblatt, *Handbook of Chemical Property Estimation Methods*, Washington, D.C, American Chemical Society, 1990.
- Macalaldy, D. L., P. G. Tratnyek, and T. J. Grundl, "Abiotic Reduction Reactions of Anthropogenic Organic Chemicals in Anaerobic Systems: A Critical Review," *J. Cont. Hydrol.*, 1:1-28, 1986.
- Mackay, D., and P. J. Leinonen, "Rate of Evaporation of Low Solubility Contaminants from Water Bodies to Atmosphere," *Environ. Sci. Technol.* 9:1178-1180, 1975.
- Mackay, D., and A. W. Wolkoff, "Rate of Evaporation of Low Solubility Contaminants from Water Bodies to Atmosphere," *Environ. Sci. Technol.* 7:611-614, 1973.
- Mackay, D., W. Y. Shiu, and R. P. Sutherland, "Determination of Air-Water Henry's Law Constants for Hydrophobic Pollutants," *Environ. Sci. Technol.* 13:333-337, 1979.
- Maymó-Gatell, X., Y. Chien, J. M. Gossett, and S. H. Zinder, "Isolation of a Bacterium that Reductively Dechlorinates Tetrachloroethene to Ethene," *Science*, 276:1568-1571, 1997.
- Mo, K., C. O. Lora, A. E. Wanken, M. Javanmardian, X. Yang, C. F. Kulpa, "Biodegradation of Methyl *t*-butyl Ether by Purce Bacterial Cultures," *Applied Microbiol. Biotechnol.*, 47:69-72, 1997.
- Mormile, M. R., S. Liu, and J. M. Suflita, "Anaerobic Biodegradation of Gasoline Oxygenates: Extrapolation of Information to Multiple Sites and Redox Conditions," *Environ. Sci. Technol.*, 28, pp., 1727-1732, 1994.
- Pankow, J. F., and J. A. Cherry, *Dense Chlorinated Solvents and Other DNAPLs in Groundwater*, Portland, Waterloo Press, 1996.
- Pignatello, J. P., and B. Xing, "Mechanisms of Slow Sorption of Organic Chemicals to Natural Particles," *Environ. Sci. Technol.*, 10:1-11, 1995.
- Rao, P. S. C., and J. M. Davidson, "Estimation of Pesticide Retention and Transformation Parameters Required in Nonpoint Source Pollution Models," *Environmental Impact of Nonpoint Source Pollution*, M. R. Overcash and J. M. Davidson, Eds., Ann Arbor, MI, Ann Arbor Science Publishers, 1980.
- Reiger, P. G. and H. J. Knackmuss, *Biodegradation of Nitroaromatic Compounds*; Spain, J.C. Ed., 49:1-18, New York, Plenum Press, 1995.
- Roberts, P. V., M. N. Goltz, and D. M. Mackay, "A Natural Gradient Experiment on Solute Transport in a Sand Aquifer. 3. Retardation Estimates and Mass Balances for Organic Solutes," *Water Resources Res.*, (2213):2047-2058, 1986.
- Salanitro, J. P., L. A. Diaz, M. P. Williams, and H. L. Wisniewski, "Isolation of a Bacterial Culture That Degrades Methyl *t*-Butyl Ether," *Applied and Environmental Microbiology*, vol. 60, No. 7, pp. 2593-2596, 1994.
- Schirmer, Mario, and James F. Barker, "A Study of Long-Term MTBE Attenuation in the Border," Aquifer, Ontario, Canada, *Ground Water Monitoring and Review*, pp. 113-122, 1998.
- Schwartzenbach, R. P., P. M. Gschwend, and D. M. Imboden, *Environmental Organic Chemistry*, New York, John S. Wiley and Sons, 1993.

- Squillace, Paul J., J. F. Pankow, N. E. Kortess, and J. S. Zogorski, "Review of The Environmental Behavior and Fate of Methyl *tert*-Butyl Ether," *Environmental Toxicology and Chemistry*, Vol. 16(9), pp. 1836-1844, 1997.
- Steffan, Robert J., K. McClay, S. Vainberg, C. W. Condee, and D. Zhang, "Biodegradation of the Gasoline Oxygenates Methyl *tert*-Butyl Ether, Ethyl *tert*-Butyl Ether, and *tert*-Amyl Methyl Ether by Propane-Oxidizing Bacteria," *Applied and Environmental Microbiology*, Vol. 63, No. 11, pp. 4216-4222, 1997.
- Swartzenbach, R. P., R. Stierli, and J. Zeyer, "Quinone and Iron Porphyrin Mediated Reduction of Nitroaromatic Compounds in Homogeneous Aqueous Solutions," *Environ. Sci. Technol.*, 24:1566-1574, 1990.
- Thibodeaux, L. T., *Environmental Chemodynamics: Movement of Chemicals in Air, Water, and Soil*, New York, John S. Wiley and Sons, 1996.
- Vogel, T. M., C. Criddle, and P. L. McCarty, "Transformation of Halogenated Aliphatic Compounds," *Environ. Sci. Technol.*, 21:722-736, 1987.
- Vogel, T.M. and P. L. McCarty, "Biotransformation of Tetrachloroethylene to Trichloroethylene, Dichloroethylene, Vinyl Chloride, and Carbon Dioxide Under Methanogenic Conditions," *Appl. Environ. Microbiol.*, 49:1080-1083, 1985.
- Vogel, T. M. and P. L. McCarty, "Abiotic and Biotic Transformation of 1,1,1-Trichloroethane under Methanogenic Conditions," *Environ. Sci. Technol.*, 21:1208-1213, 1987.
- Weber, W. J. and F. A. DiGiano, *Process Dynamics in Environmental Systems*, New York, John S. Wiley and Sons, 1996.
- Wood, J. M., F. S. Kennedy, and R. S. Wolfe, "The Reaction of Mutli Halogenated Hydrocarbons with Free and Bound Reduced Vitamin B12," *Biochemistry*, 7:1707-1713, 1968.
- Yeh, Carol K. and John T. Novak, "Anaerobic Biodegradation of Gasoline Oxygenates in Soils," *Water Environment Research*, Vol. 66, No. 5, pp., 744-752, 1994.
- Young, L. Y., C. E. Cerniglia, *Microbial Transformation and Degradation of Toxic Organic Chemicals*, New York, John S. Wiley and Sons, 1995.

Library of Congress Cataloging-in-Publication Data

Bedient, Philip B., 1948-

Ground water contamination : transport and remediation / Philip B. Bedient, Hanadi s. Rifai,
Charles J. Newell. -- 2nd ed.

p. cm.

Includes bibliographical references and index.

ISBN 0-13-013840-1

1. Groundwater--Pollution. 2. Groundwater--Quality--Management.

I. Rifai, H.S. II. Newell, Charles J. III. Title.

TD426.B44 1999

628.1'68--dc21

99-38305

CIP

Editorial/production supervision: *Vincent Janoski*

Acquisitions editor: *Bernard Goodwin*

Marketing manager: *Lisa Konzelmann*

Manufacturing manager: *Alan Fischer*

Editorial assistant: *Diane Spina*

Cover design director: *Jerry Votta*

©1999 by Prentice-Hall

Published by Prentice Hall PTR

Prentice-Hall, Inc.

Upper Saddle River, NJ 07458

Prentice Hall books are widely used by corporations and government agencies
for training, marketing, and resale.

The publisher offers discounts on this book when ordered in bulk quantities.

For more information, contact: Corporate Sales Department, Phone: 800-382-3419;

Fax: 201-236-7141; E-mail: corpsales@prenhall.com; or write: Prentice Hall PTR,

Corp. Sales Dept., One Lake Street, Upper Saddle River, NJ 07458.

All figures taken from other sources are reprinted by permission of their respective copyright owners.

All products or services mentioned in this book are the trademarks or service marks of their respective
companies or organizations.

All rights reserved. No part of this book may be reproduced, in any form or by any means, without permission
in writing from the publisher.

Printed in the United States of America

10 9 8 7 6 5 4 3 2 1

ISBN 0-13-013840-1

Prentice-Hall International (UK) Limited, London

Prentice-Hall of Australia Pty. Limited, Sydney

Prentice-Hall Canada Inc., Toronto

Prentice-Hall Hispanoamericana, S.A., Mexico

Prentice-Hall of India Private Limited, New Delhi

Prentice-Hall of Japan, Inc., Tokyo

Prentice-Hall Singapore Pte. Ltd., Singapore

Editora Prentice-Hall do Brasil, Ltda., Rio de Janeiro